















SFI SYSTEM (2JZ-GE)



PREPARATION

SST (SPECIAL SERVICE TOOLS)

	09205-76030 Cylinder Head Setting Bolt Tightening Adaptor	ECT sensor
	09268-41045 Injection Measuring Tool Set	
	(09268-41070) No.4 Union	
	(09268-41090) No.7 Union	
	(90405-09015) No.1 Union	
	09268-45012 EFI Fuel Pressure Gauge	
	09612-24014 Steering Gear Housing Overhaul Tool Set	
	(09617-24011) Steering Rack Wrench	Fuel pressure pulsation damper
	09631-22020 Power Steering Hose Nut 14 x 17 mm Wrench Set	Fuel line flare nut
	09808-14010 Fuel Sender Gauge Tool Assy	
	09816-30010 Oil Pressure Switch Socket	Knock sensor
	09842-30070 Wiring "F" EFI Inspection	Injector

	09843-18020	Diagnostic Check Wire	
	09990-01000	Engine Control Computer Check Harness "A"	

RECOMMENDED TOOLS

	09082-00050	TOYOTA Electrical Tester Set	
	09200-00010	Engine Adjust Kit	
	09258-00030	Hose Plug Set	Plug for vacuum hose, fuel hose etc.

EQUIPMENT

Carburetor cleaner	
Graduated cylinder	Injector
Soft brush	
Sound scope	Injector
Tachometer	
Torque wrench	
Vacuum gauge	

COOLANT

Item		Capacity	Classification
Engine coolant (w/ Heater)	M/T A/T	7.3 liters (7.7 US qts, 6.4 Imp. qts) 8.3 liters (8.8 US qts, 7.3 Imp. qts)	Ethylene-glycol base

PRECAUTION

1. **Before working on the fuel system, disconnect the negative (-) terminal cable from the battery.**
 HINT: Any diagnostic trouble code retained by the computer will be erased when the negative (-) terminal cable is disconnected.
 Therefore, if necessary, read the diagnosis before disconnecting the negative (-) terminal cable from the battery.
2. **Do not smoke or work near an open flame when working on the fuel system.**
3. **Keep gasoline away from rubber or leather parts.**

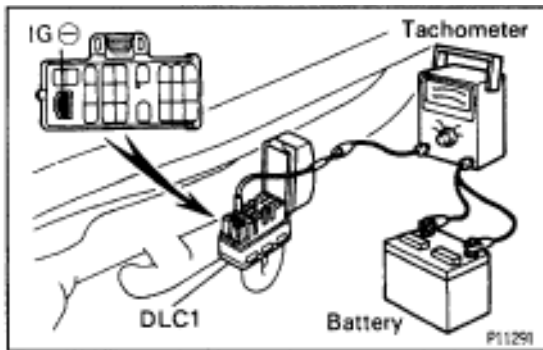

MAINTENANCE PRECAUTIONS

1. PRECAUTION WHEN CONNECTING GAUGE

- (a) Use battery as the power source for the timing light, tachometer, etc.
- (b) Connect the tester probe of a tachometer to the terminal IG \ominus of the DLC1.

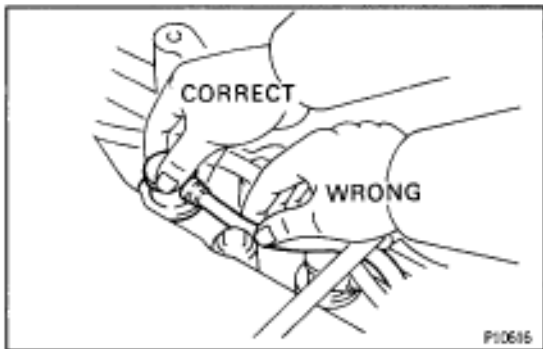

2. IN EVENT OF ENGINE MISFIRE, FOLLOWING PRECAUTIONS SHOULD BE TAKEN

- (a) Check proper connection of battery terminals, etc.
- (b) Handle high-tension cords carefully.
- (c) After repair work, check that the ignition coil terminals and all other ignition system lines are reconnected securely.
- (d) When cleaning the engine compartment, be especially careful to protect the electrical system from water.

3. PRECAUTIONS WHEN HANDLING OXYGEN SENSOR

- (a) Do not allow oxygen sensor to drop or hit against an object.
- (b) Do not allow the sensor to come into contact with water.

IF VEHICLE IS EQUIPPED WITH MOBIL RADIO SYSTEM (HAM, CB, ETC.)

If the vehicle is equipped with a mobile communication system, refer to the precaution in the IN section.

AIR INDUCTION SYSTEM

1. Separation of the engine oil dipstick, oil filler cap, PCV hose, etc. may cause the engine to run out of tune.
2. Disconnection, looseness or cracks in the parts of the air induction system between the throttle body and cylinder head will cause air suction and cause the engine to run out of tune.

ELECTRONIC CONTROL SYSTEM

1. Before removing SFI wiring connectors, terminals, etc., first disconnect the power by either turning the ignition switch OFF or disconnecting the negative (–) terminal cable from the battery.
HINT: Always check the diagnostic trouble code before disconnecting the negative (–) terminal cable from the battery.
2. When installing the battery, be especially careful not to incorrectly connect the positive (+) and negative (–) cables.
3. Do not permit parts to receive a severe impact during removal or installation. Handle all SFI parts carefully, especially the ECM.
4. Do not be careless during troubleshooting as there are numerous transistor circuits and even slight terminal contact can cause further troubles.
5. Do not open the ECM cover.
6. When inspecting during rainy weather, take care to prevent entry of water. Also, when washing the engine compartment, prevent water from getting on the SFI parts and wiring connectors.
7. Parts should be replaced as an assembly.
8. Care is required when pulling out and inserting wiring connectors.
 - (a) Release the lock and pull out the connector, pulling on the connectors.
 - (b) Fully insert the connector and check that it is locked.

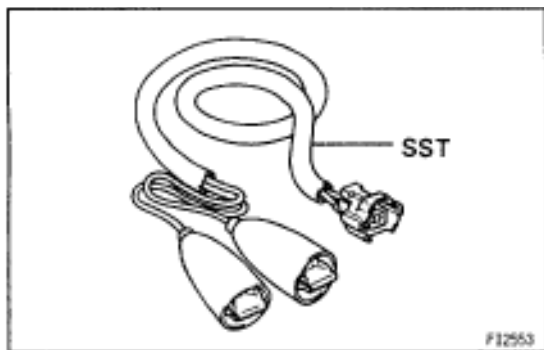

9. Use SST for inspection or test of the injector or its wiring connector.
SST 09842-30070

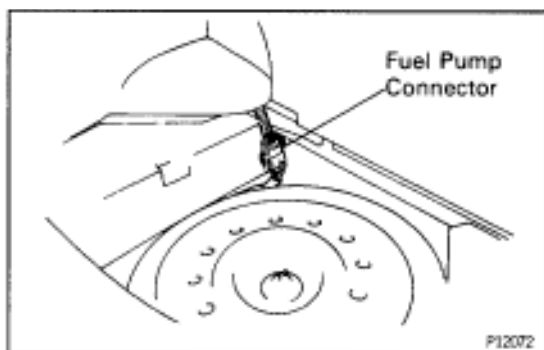

FUEL SYSTEM

1. When disconnecting the high pressure fuel line, a large amount of gasoline will spill out, so observe the following procedures:
- Disconnect the fuel pump connector.
 - Start the engine. After the engine has stopped on its own, turn off the ignition switch.

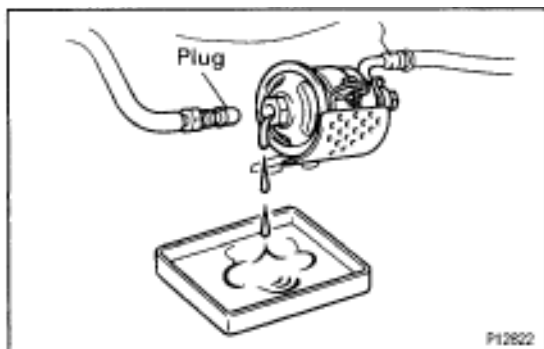

- Put a container under the connection.
- Slowly loosen the connection.
- Disconnect the connection.
- Plug the connection with a rubber plug.
- Reconnect the fuel pump connector.

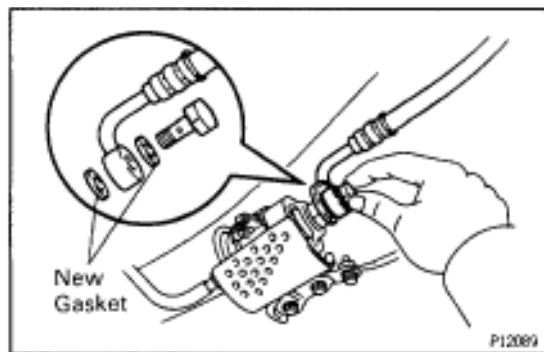

2. When connecting the flare nut or union bolt on the high pressure pipe union, observe the following procedures:

Union Bolt Type:

- Always use a new gasket.
- Tighten the union bolt by hand.
- Tighten the union bolt to the specified torque.

Torque: 29 N·m (300 kgf·cm, 22 ft·lbf)

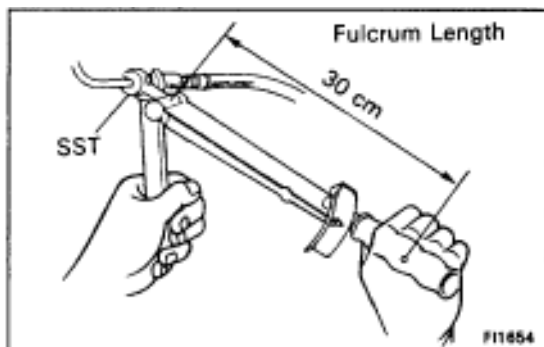

Flare Nut Type:

- Apply a light coat of engine oil to the flare nut, and tighten the flare nut by hand.
- Using SST, tighten the flare nut to specified torque.

SST 09631-22020

Torque: 30 N·m (310 kgf·cm, 22 ft·lbf)

HINT: Use a torque wrench with a fulcrum length of 30 cm (11.81 in.).

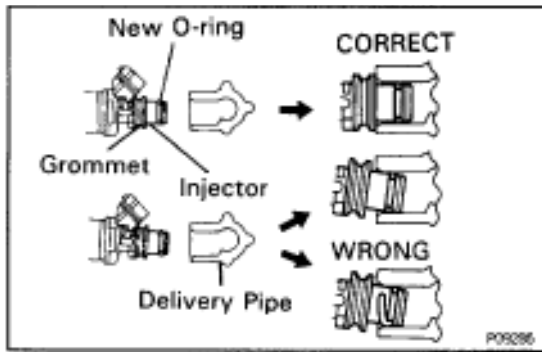

3. Observe the following precautions when removing and installing the injectors.
 - (a) Never reuse the O-ring.
 - (b) When placing a new O-ring on the injector, take care not to damage it in any way.
 - (c) Coat a new O-ring with spindle oil or gasoline before installing—never use engine, gear or brake oil.

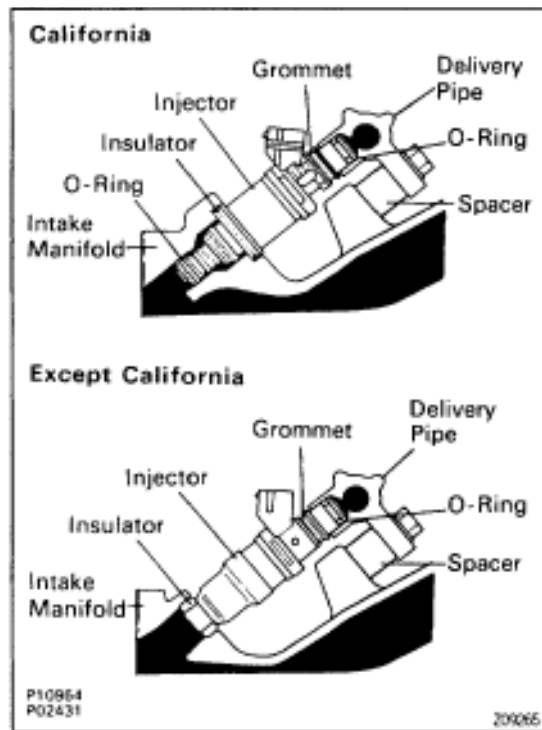

4. Install the injector to the delivery pipe and intake manifold as shown in the illustration.

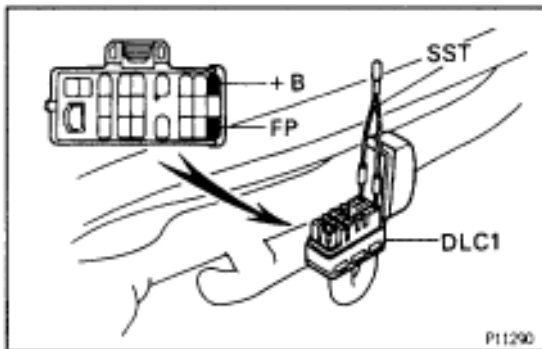

5. Check that there are no fuel leaks after doing maintenance anywhere on the fuel system.
 - (a) Using SST, connect terminals +B and FP of the DLC 1. SST 09843-18020
 - (b) With engine stopped, turn the ignition switch ON.

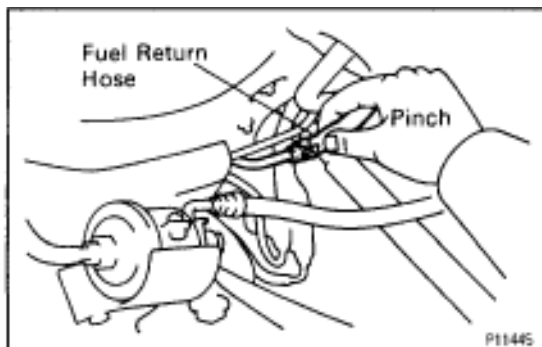

- (c) Pinch the fuel return hose. The pressure in the high pressure line will rise to approx. 392 kPa (4 kgf/cm², 57 psi). In this state, check to see that there are no leaks from any part of the fuel system.

NOTICE: Always pinch the hose. Avoid bending as it may cause the hose to crack.

 - (d) Turn the ignition switch OFF.
 - (e) Remove the SST from the DLC1. SST 09843-18020

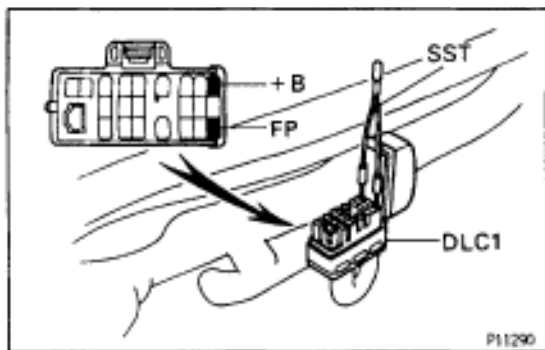

FUEL PUMP ON-VEHICLE INSPECTION

1. CHECK FUEL PUMP OPERATION

- Using SST, connect terminals +B and FP of the DLC 1.
SST 09843-18020
- Turn the ignition switch ON.
NOTICE: Do not start the engine.

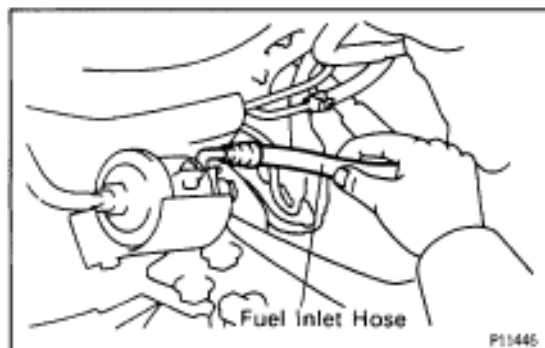

- Check that there is pressure in the fuel inlet hose from the fuel filter.
HINT: If there is fuel pressure, you will hear the sound of fuel flowing.

If there is no pressure, check the following parts:

- Fuse
- EFI main relay
- Fuel pump
- ECM
- Wiring connections

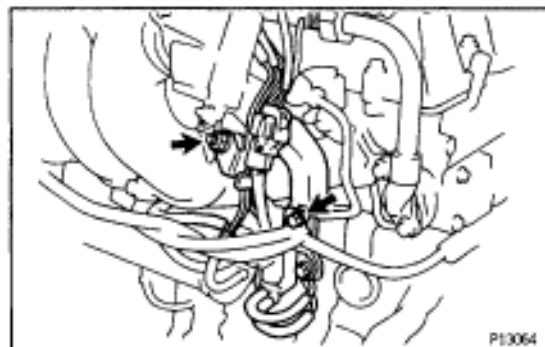

- Turn the ignition switch OFF.
- Remove the SST from the DLC1.
SST 09843-18020

2. CHECK FUEL PRESSURE

- Check the battery voltage is above 12 V.
- Disconnect the negative (-) terminals cable from the battery.
- Remove the 2 nuts, and disconnect the No.2 vacuum pipe from the air intake chamber and intake manifold.



- Remove the union bolt and 2 gaskets, disconnect the fuel inlet pipe from the delivery pipe.

CAUTION:

**Put a shop towel under the delivery pipe.
Slowly loosen the union bolt.**

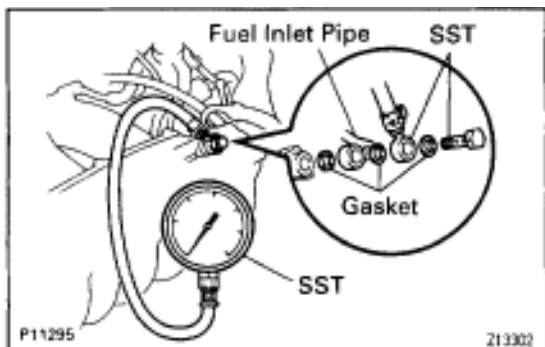

- Install the fuel inlet pipe and SST (pressure gauge) to the delivery pipe with the 3 gaskets and SST (union bolt).
SST 09268-45012
Torque: 42 N·m (420 kgf·cm, 30 ft·lbf)
- Wipe off any splattered gasoline.
- Using SST, connect terminals +B and FP of the DLC 1.
SST 09843-18020

- (h) Reconnect the negative (–) terminal cable to the battery.
- (i) Turn the ignition switch ON.
- (j) Measure the fuel pressure.

Fuel pressure:

265–304 kPa (2.7–3.1 kgf/cm², 38–44 psi)

If pressure is high, replace the fuel pressure regulator.

If pressure is low, check the following parts:

- Fuel hoses and connections
- Fuel pump
- Fuel filter
- Fuel pressure regulator

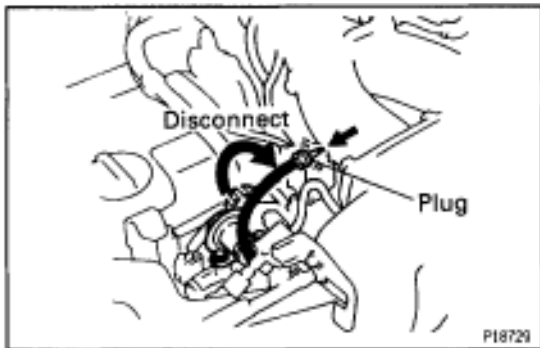

- (k) Remove the SST from the DLC1.
SST 09843–18020
- (l) Start the engine.
- (m) Disconnect the vacuum sensing hose from the fuel pressure regulator, and plug the hose end.
- (n) Measure the fuel pressure at idle.

Fuel pressure:

265–304 kPa (2.7–3.1 kgf/cm², 38–44 psi)

- (o) Reconnect the vacuum sensing hose to the fuel pressure regulator.
- (p) Measure the fuel pressure at idle.

Fuel pressure:

196–235 kPa (2.0–2.4 kgf/cm², 28–34 psi)

If pressure is not as specified, check the vacuum sensing hose and fuel pressure regulator.

- (q) Stop the engine.
- (r) Check that the fuel pressure remains as specified for 5 minutes after the engine has stopped.

Fuel pressure:

147 kPa (1.5 kgf/cm², 21 psi) or more

If pressure is not as specified, check the fuel pump, pressure regulator and/or injectors.

- (s) After checking fuel pressure, disconnect the negative (–) terminal cable from the battery and carefully remove the SST to prevent gasoline from splashing.

SST 09268–45012

- (t) Install the fuel inlet pipe to the delivery pipe with 2 new gaskets and the union bolt.

Torque: 42 N·m (420 kgf·cm², 30 ft·lbf)

- (u) Install the No.2 vacuum pipe with the 2 nuts.

Torque: 27 N·m (270 kgf·cm², 20 ft·lbf)

- (v) Reconnect the negative (–) terminal cable to the battery.
- (w) Check for fuel leaks.

(See item 5 in fuel system in precaution)

COMPONENTS FOR REMOVAL AND INSTALLATION

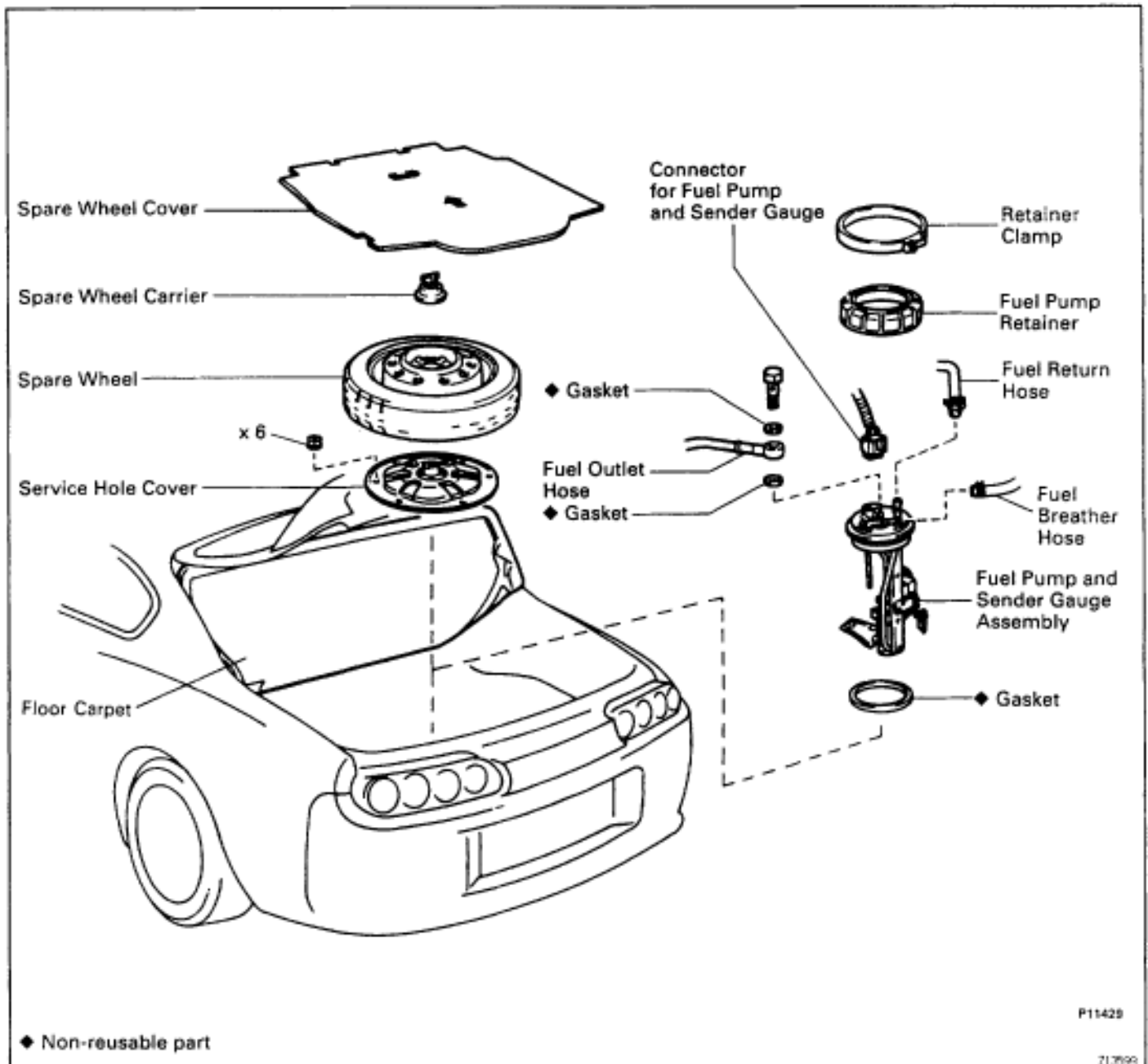

FUEL PUMP REMOVAL

CAUTION: Do not smoke or work near an open flame when working on the fuel pump.

1. TAKE OUT FLOOR CARPET
2. REMOVE SPARE WHEEL COVER
3. REMOVE SPARE WHEEL
4. REMOVE SERVICE HOLE COVER

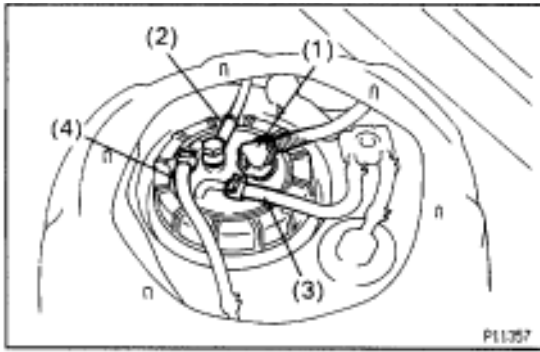

5. REMOVE FUEL PUMP AND SENDER GAUGE ASSEMBLY

(a) Disconnect the connector and hoses from the fuel pump bracket:

(1) Fuel pump connector

(2) Fuel outlet hose

Remove the union bolt and 2 gaskets, and disconnect the outlet hose.

(3) Fuel return hose

(4) Fuel breather hose

(b) Remove the retainer clamp.

(c) Using SST, loosen the retainer.

SST 09808-14010

(d) Remove the retainer, the fuel pump, sender gauge assembly and gasket.

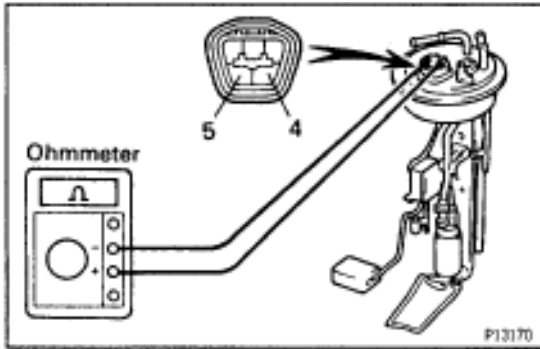
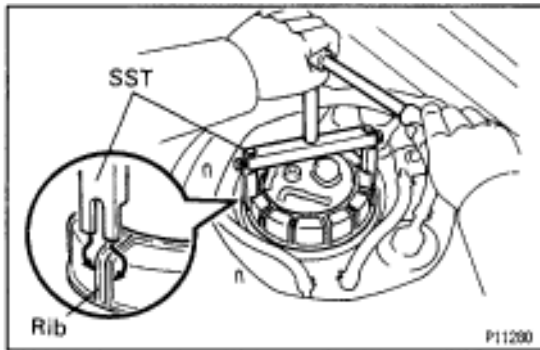

FUEL PUMP INSPECTION

1. INSPECT FUEL PUMP RESISTANCE

Using an ohmmeter, measure the resistance between terminals 4 and 5.

Resistance:

0.2-3.0 Ω at 20°C (68°F)

If the resistance is not as specified, replace the fuel pump, lead wire or fuel pump bracket.

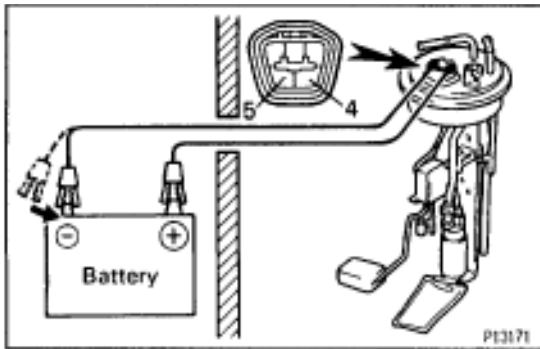

2. INSPECT FUEL PUMP OPERATION

Connect a tester lead from terminal 4 of the connector to the positive (+) terminal of the battery; connect another tester lead from terminal 5 of the connector to the negative (-) terminal of the battery.

NOTICE:

These tests must be performed quickly (within 10 seconds) to prevent the coil from burning out.

Keep the fuel pump as far away from the battery as possible.

Always connect or disconnect at the battery.

If operation is not as specified, replace the fuel pump, lead wire or fuel pump bracket.

COMPONENTS FOR DISASSEMBLY AND ASSEMBLY

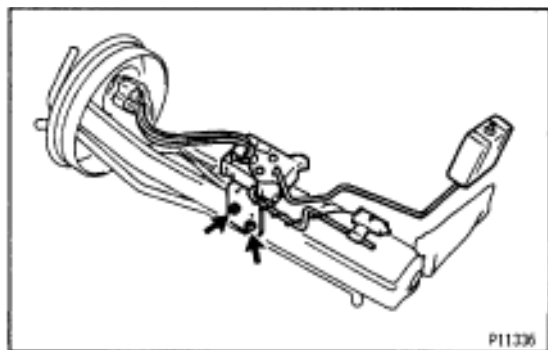
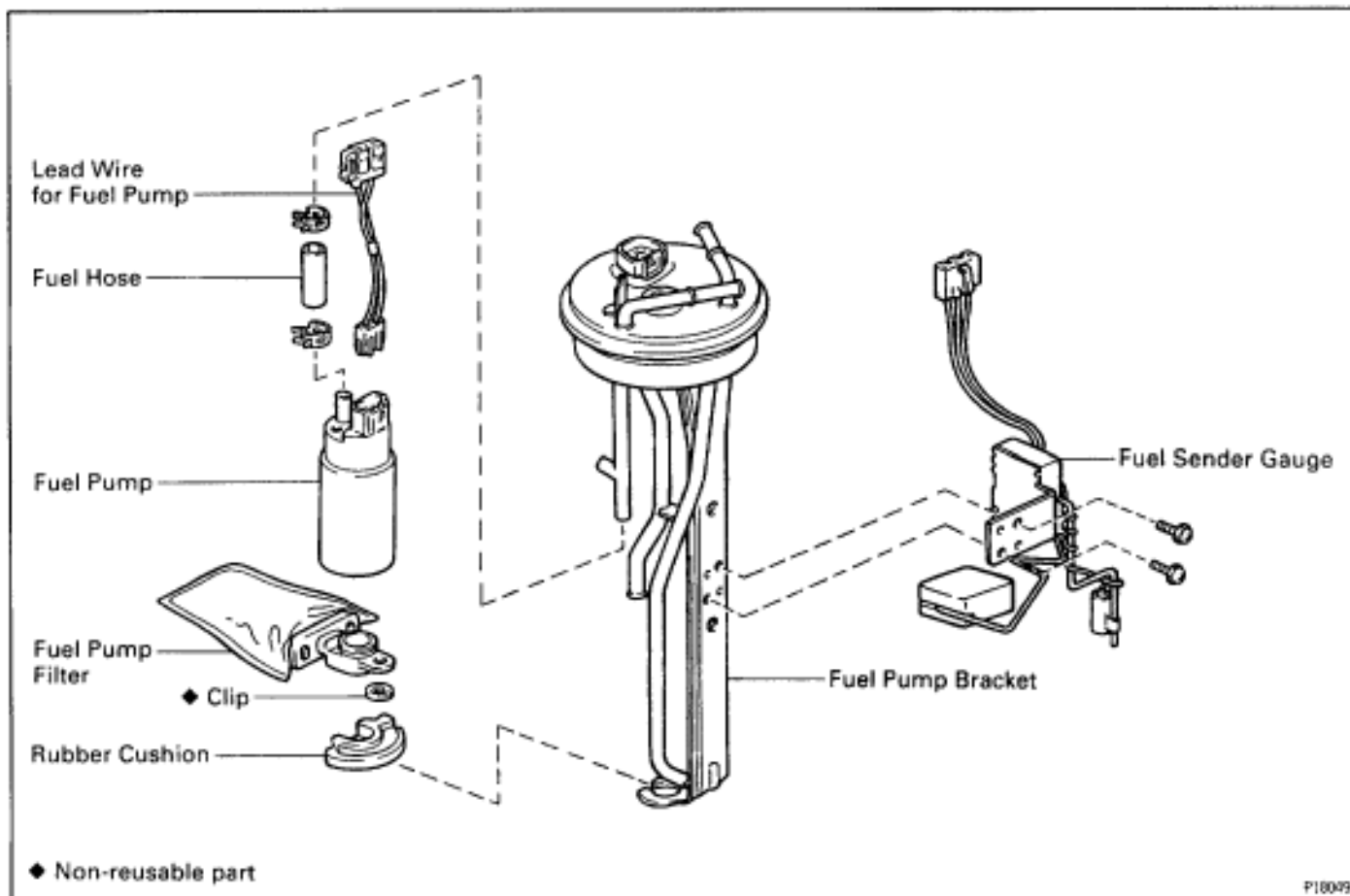

FUEL PUMP DISASSEMBLY

Assembly is in the reverse order of disassembly.

1. REMOVE FUEL SENDER GAUGE FROM FUEL PUMP BRACKET

- (a) Disconnect the connector from the fuel pump bracket.
- (b) Remove the 2 screws and sender gauge.

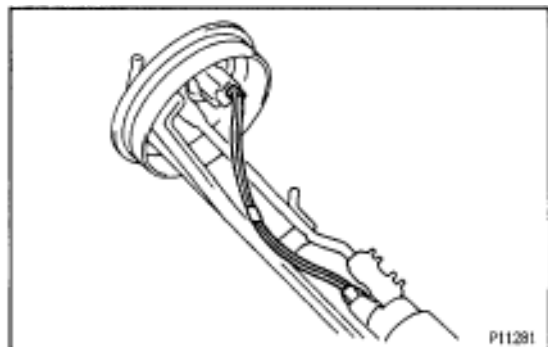

2. REMOVE FUEL PUMP FROM PUMP BRACKET

- (a) Remove the lead wire.

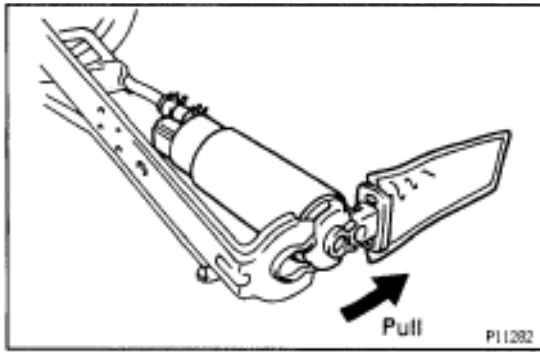

- (b) Pull out the lower side of the fuel pump from the pump bracket.
- (c) Remove the rubber cushion from the fuel pump.
- (d) Disconnect the fuel hose from the fuel pump, and remove the fuel pump.

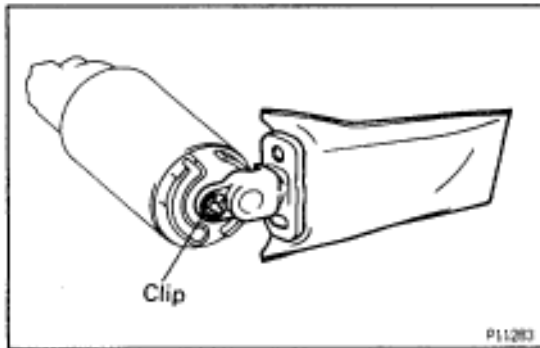

3. REMOVE FUEL PUMP FILTER FROM FUEL PUMP

- (a) Using a small screwdriver, remove the clip.
INSTALLATION HINT: Use a new clip.
- (b) Pull out the pump filter.

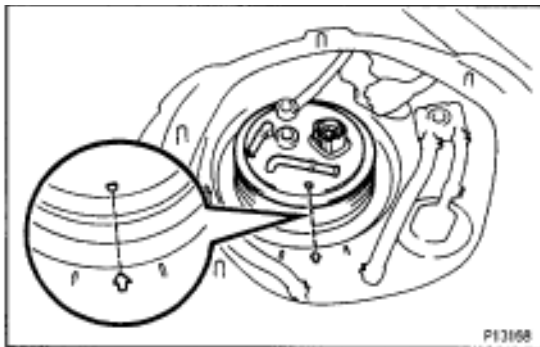

FUEL PUMP INSTALLATION

1. INSTALL FUEL PUMP AND SENDER GAUGE ASSEMBLY

- (a) Install a new gasket to the fuel tank.
- (b) Insert fuel pump and sender gauge assembly into the fuel tank.
- (c) Align the arrow marks of the fuel pump bracket and fuel tank.

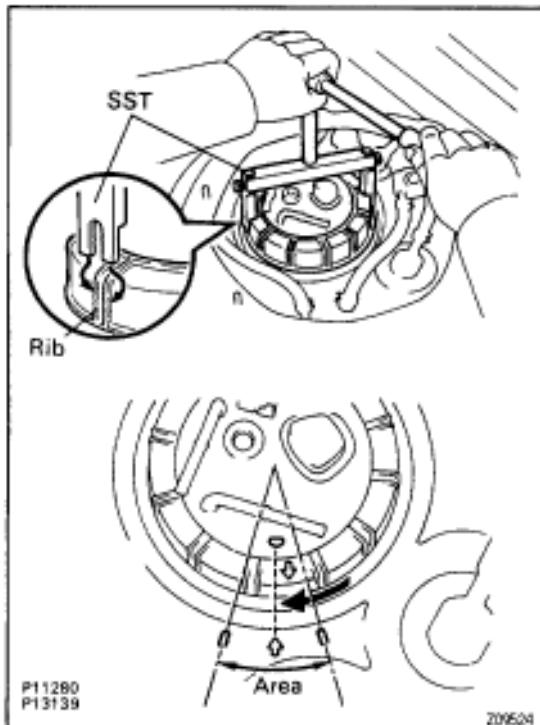

- (d) Temporarily install the retainer.
- (e) Using SST, tighten the retainer until the arrow mark on the retainer is within the lines on the fuel tank.
SST 09808-14010
- (f) Check that the arrow marks of the fuel pump bracket and fuel tank are aligned.

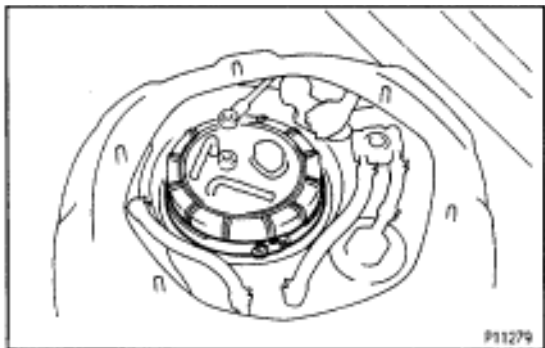

- (g) Install the retainer clamp.
- (h) Connect the connector and hoses to the fuel pump bracket:
- Fuel pump connector
 - Fuel outlet hose

Connect the outlet hose with 2 new gaskets and the union bolt.

Torque: 29 N·m (300 kgf·cm, 22 ft·lbf)

- Fuel return hose
- Fuel breather hose

- 2. REMOVE SERVICE HOLE COVER**
- 3. REMOVE SPARE WHEEL**
- 4. REMOVE SPARE WHEEL COVER**
- 5. TAKE OUT FLOOR CARPET**
- 6. CHECK FOR FUEL LEAKS**
(See item 5 in fuel system in precaution)

FUEL PRESSURE REGULATOR COMPONENTS FOR REMOVAL AND INSTALLATION

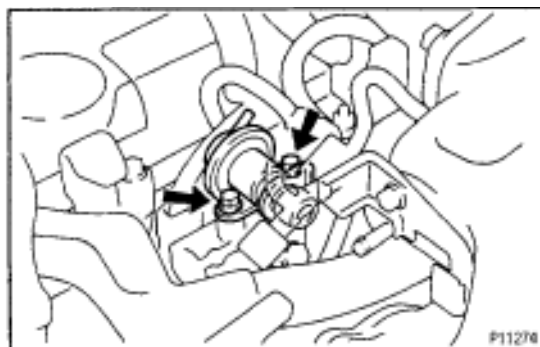
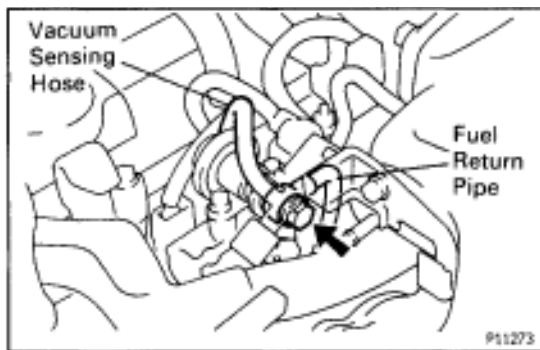
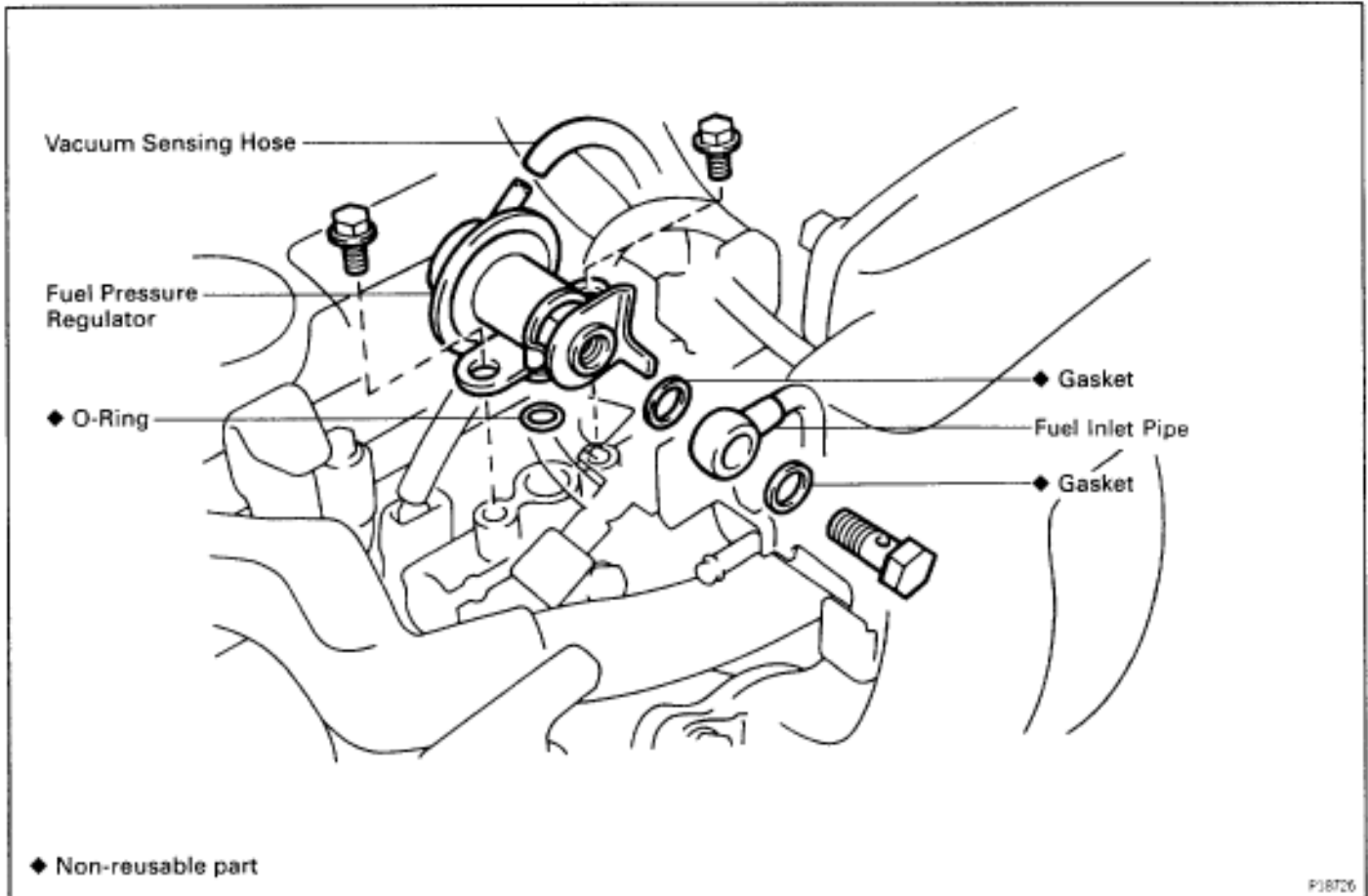

FUEL PRESSURE REGULATOR REMOVAL

1. DISCONNECT VACUUM SENSING HOSE FROM FUEL PRESSURE REGULATOR
2. DISCONNECT FUEL RETURN PIPE FROM FUEL PRESSURE REGULATOR

Remove the union bolt and 2 gaskets, and disconnect the return pipe from the pressure regulator.

CAUTION:

Put a shop rag under the pressure regulator.

Slowly loosen the union bolt.

3. REMOVE FUEL PRESSURE REGULATOR
 - (a) Remove the 2 bolts, and pull out the pressure regulator.
 - (b) Remove the O-ring from the pressure regulator.

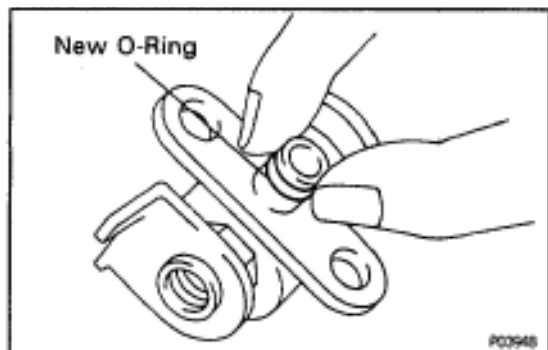

FUEL PRESSURE REGULATOR INSTALLATION

1. INSTALL FUEL PRESSURE REGULATOR

- (a) Apply a light coat of gasoline to a new O-ring, and install it to the pressure regulator.

- (b) Attach the pressure regulator to the delivery pipe.

- (c) Check that the pressure regulator rotates smoothly.

NOTICE: If it does not rotate smoothly, the O-ring may be pinched, so remove the pressure regulator and do steps (b) and (c) above again.

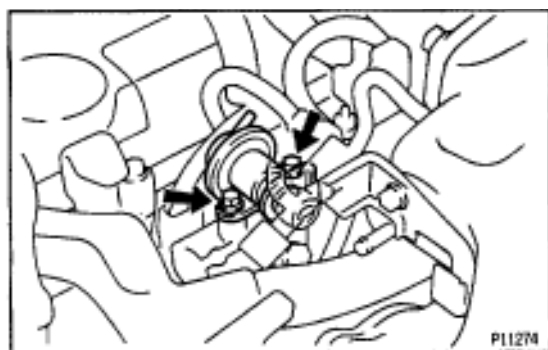
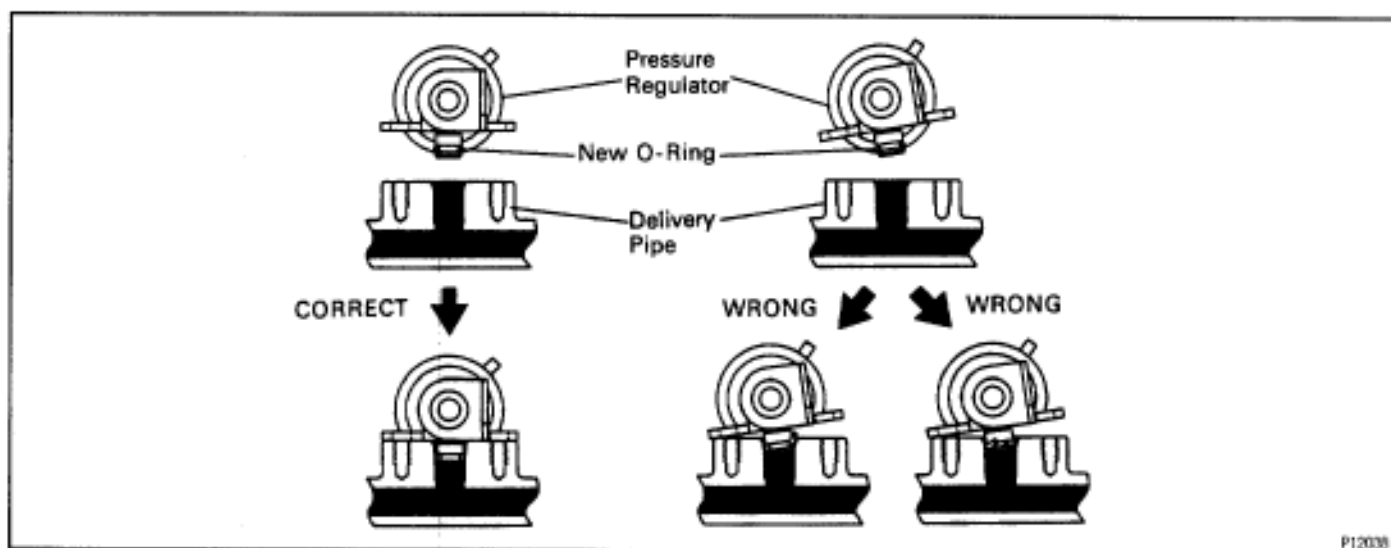

- (d) Install the pressure regulator with the 2 bolts.

Torque: 8.8 N·m (90 kgf·cm, 78 in·lbf)

2. CONNECT FUEL RETURN PIPE TO FUEL PRESSURE REGULATOR

Install the return pipe with 2 new gaskets and the union bolt.

Torque: 27 N·m (280 kgf·cm, 20 ft·lbf)

3. CONNECT VACUUM SENSING HOSE TO FUEL PRESSURE REGULATOR

4. CHECK FOR FUEL LEAKS

(See item 5 in fuel system in precaution)

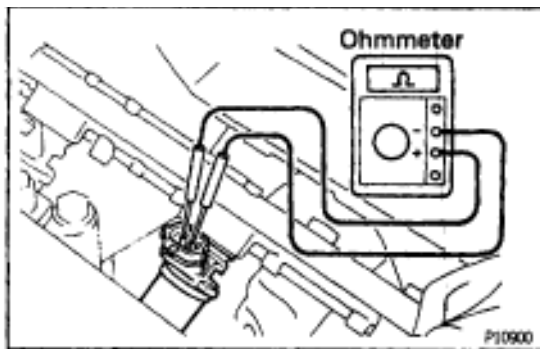
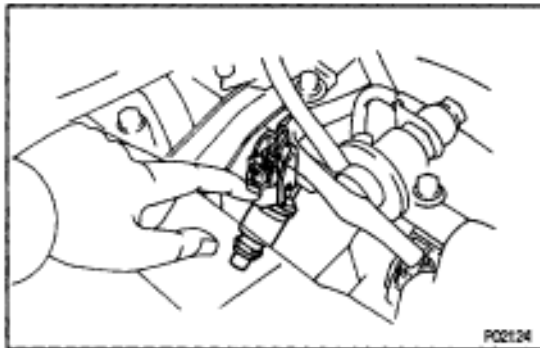
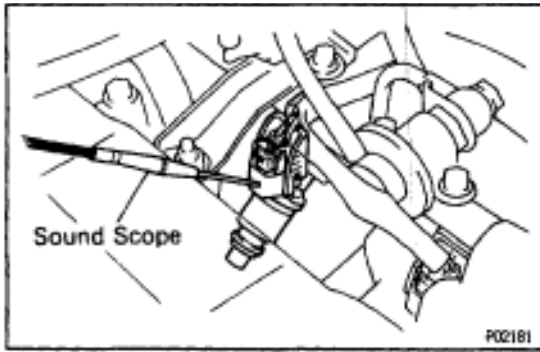

INJECTOR ON-VEHICLE INSPECTION

1. INSPECT INJECTOR OPERATION

Check operation sound from each injector.

- (a) With the engine running or cranking, use a sound scope to check that there is normal operating noise in proportion to engine speed.
- (b) If you have no sound scope, you can check the injector transmission operation with your finger. If no sound is heard or unusual vibration is felt, check the wiring connector, injector or injection signal from the ECM.

2. INSPECT INJECTOR RESISTANCE

- (a) Remove the throttle body together with the intake air connector. (See steps 1 to 9 in injector removal)
- (b) Disconnect the 6 injector connectors.
- (c) Using an ohmmeter, measure the resistance between the injector terminals.

Resistance:

At 20°C (68°F) 13.4–14.2 Ω

If the resistance is not as specified, replace the injector.

- (d) Reconnect the 6 injector connectors.
- (e) Reinstall the throttle body together with the intake air connector. (See steps 8 to 16 in injector installation)

COMPONENTS FOR REMOVAL AND INSTALLATION

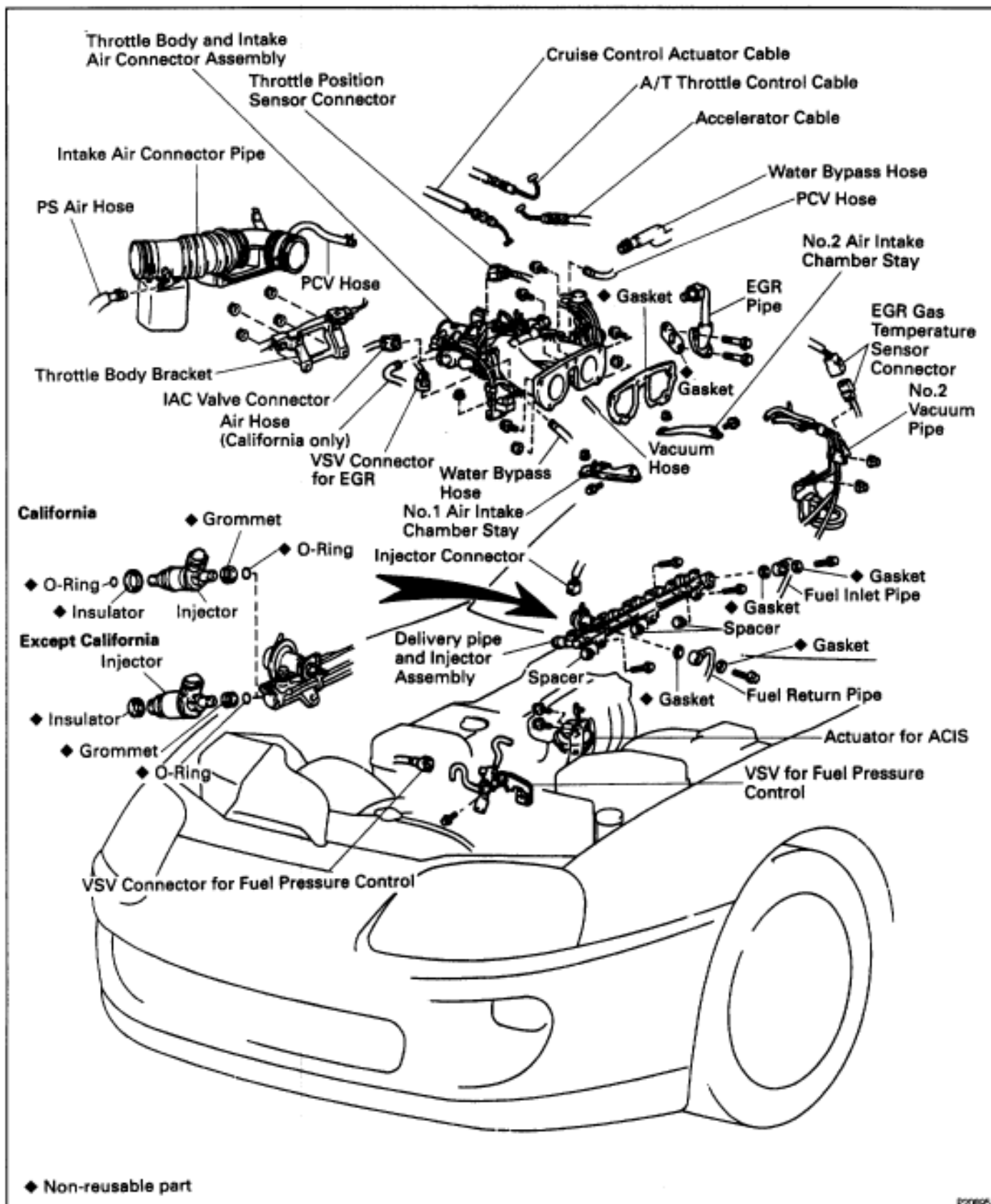

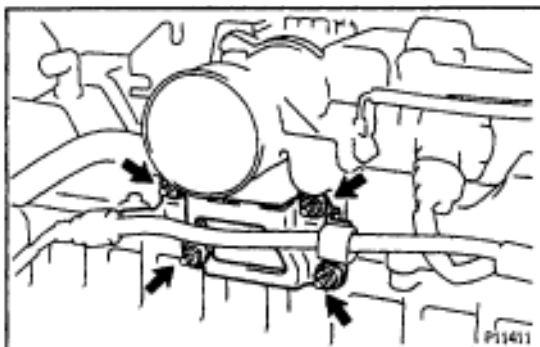
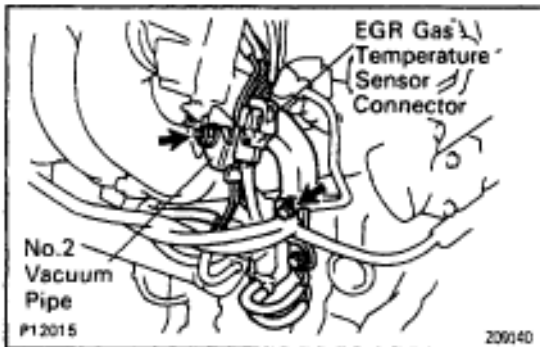
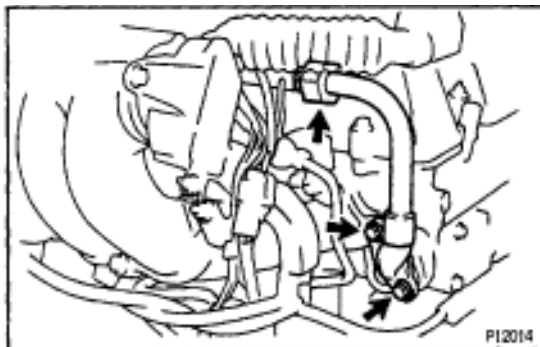
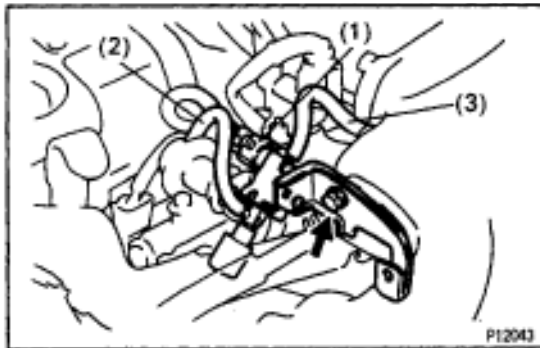
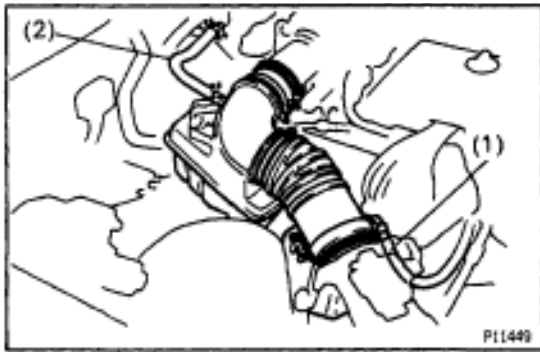

INJECTORS REMOVAL

1. **DRAIN ENGINE COOLANT**
2. **DISCONNECT CONTROL CABLES FROM THROTTLE BODY**
3. **REMOVE INTAKE AIR CONNECTOR PIPE**
 - (a) Disconnect these hoses:
 - (1) PS air hose from air connector pipe
 - (2) PCV hose from No.2 cylinder head cover
 - (b) Loosen the 2 hose clamps, and remove the air connector pipe together with the hoses.
4. **California only:**
REMOVE VSV FOR FUEL PRESSURE CONTROL
 - (a) Disconnect the connector and hoses:
 - (1) VSV connector
 - (2) Vacuum sensing hose from fuel pressure control
 - (3) Vacuum sensing hose from air intake chamber
 - (b) Remove the bolt and VSV.
5. **REMOVE EGR PIPE**
 - (a) Loosen the union nut of the EGR pipe.
 - (b) Remove the 2 bolts, EGR pipe and gasket.
6. **DISCONNECT EGR GAS TEMPERATURE SENSOR CONNECTOR**
 - (a) Disconnect the connector from the No.2 vacuum pipe.
 - (b) Disconnect the sensor connector from the wiring connector.
7. **DISCONNECT NO.2 VACUUM PIPE FROM AIR INTAKE CHAMBER AND INTAKE MANIFOLD**
Remove the 2 nuts, and disconnect the vacuum pipe from the air intake chamber and intake manifold.
8. **DISCONNECT THROTTLE BODY BRACKET FROM THROTTLE BODY AND CYLINDER HEAD**
Remove the 4 nuts, and disconnect the throttle body bracket from the throttle body and cylinder head.

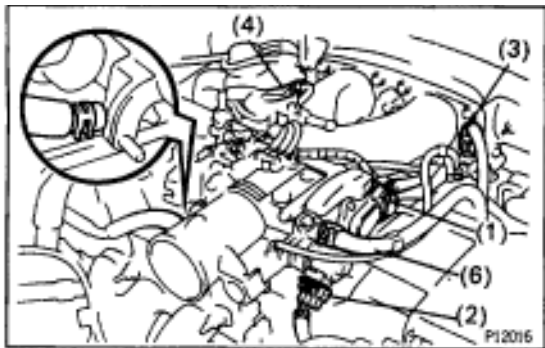

9. REMOVE THROTTLE BODY AND INTAKE AIR CONNECTOR ASSEMBLY

- (a) Disconnect these connectors and hoses:
 - (1) Throttle position sensor connector
 - (2) IAC valve connector
 - (3) VSV connector for EGR
 - (4) PCV hose from intake air connector
 - (5) Water bypass hose (from No.2 water bypass pipe) from throttle body
 - (6) California only:
Air hose from IAC valve
- (b) Remove the nut holding the VSV for the ACIS to the air intake chamber.
- (c) Remove the 4 bolts and 2 nuts holding the intake air connector to the air intake chamber.

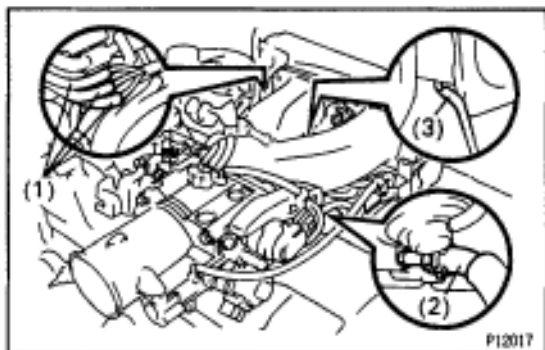
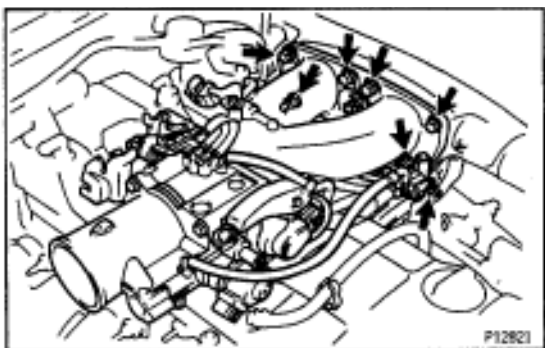

- (d) Disconnect these hoses, and remove the throttle body, intake air connector assembly and gasket.
 - (1) 3 vacuum hoses (from No.2 vacuum pipe) from No.1 vacuum pipe
 - (2) Water bypass hose (from water outlet) from throttle body
 - (3) Vacuum hose (from actuator for ACIS) from No.1 vacuum pipe

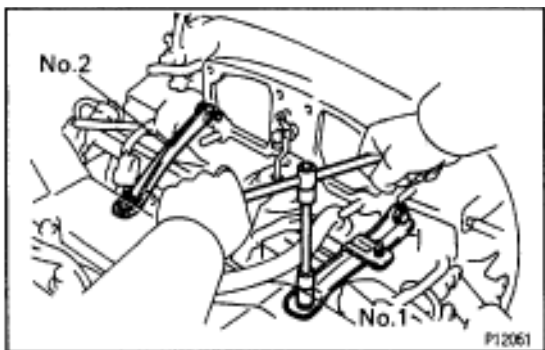

10. REMOVE AIR INTAKE CHAMBER STAYS

- (a) Remove the bolt, nut and No.1 stay.
- (b) Remove the bolt, nut and No.2 stay.

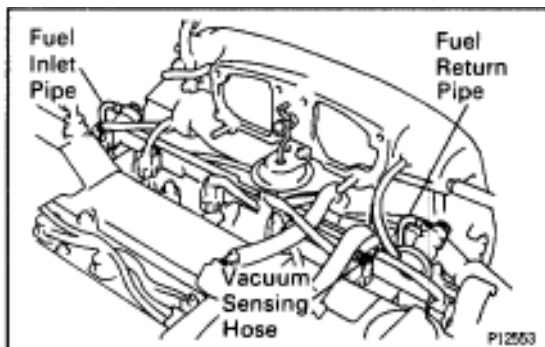

11. Except California: DISCONNECT VACUUM SENSING HOSE FROM FUEL PRESSURE REGULATOR

- ## 12. DISCONNECT FUEL INLET PIPE FROM DELIVERY PIPE
- Remove the union bolt and 2 gaskets, and disconnect the inlet pipe from the delivery pipe.

CAUTION:

Put a shop towel under the delivery pipe.

Slowly loosen the union bolt.

13. DISCONNECT FUEL RETURN PIPE FROM FUEL PRESSURE REGULATOR

Remove the union bolt and 2 gaskets, and disconnect the fuel pipe from the pressure regulator.

CAUTION:

Put a shop towel under the pressure regulator.

Slowly loosen the union bolt.

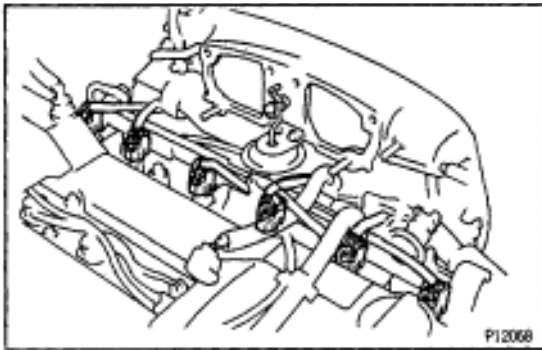

14. DISCONNECT INJECTOR CONNECTORS

Disconnect the 6 injector connectors.

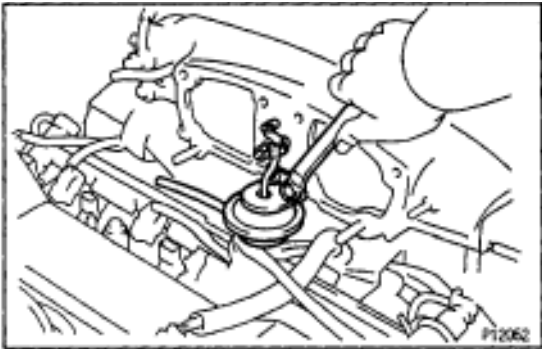

15. DISCONNECT ACTUATOR FOR ACIS FROM AIR INTAKE CHAMBER

- (a) Remove the 2 bolts, and disconnect the actuator from the air intake chamber.

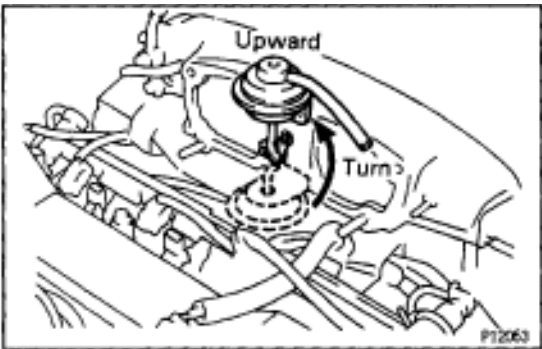

- (b) Wrap the actuator with adhesive tape and attach it to the intake chamber.

NOTICE: Do not apply any force on the actuator rod and prevent the rod clip from detaching.

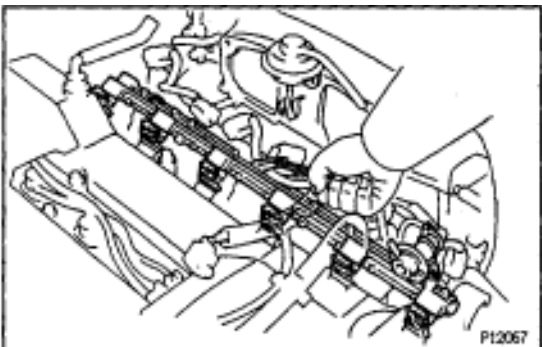

16. REMOVE DELIVERY PIPE AND INJECTORS

- (a) Remove the 3 bolts and delivery pipe together with the 6 injectors.

NOTICE: Be careful not to drop the injectors when removing the delivery pipe.

- (b) Remove the 6 insulators (Except California) and 3 spacers from the intake manifold.

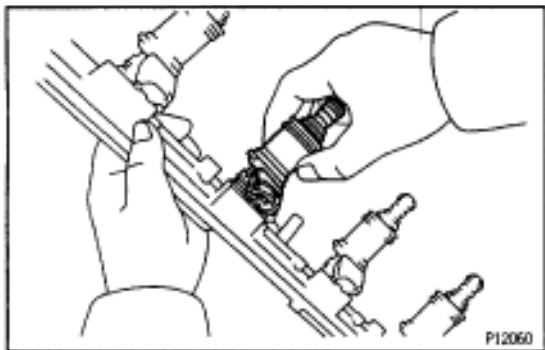

- (c) Pull out the 6 injectors from the delivery pipe.
- (d) California:
Remove the 2 O-rings, insulator and grommet from each injector.
- (e) Except California:
Remove the O-ring and grommet from each injector.

INJECTORS INSPECTION

1. INSPECT INJECTOR INJECTION

CAUTION: Keep injector clear of sparks during the test.

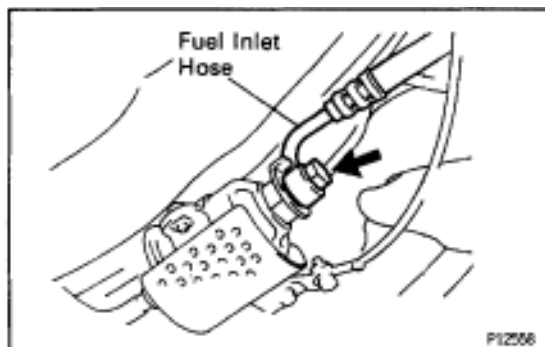
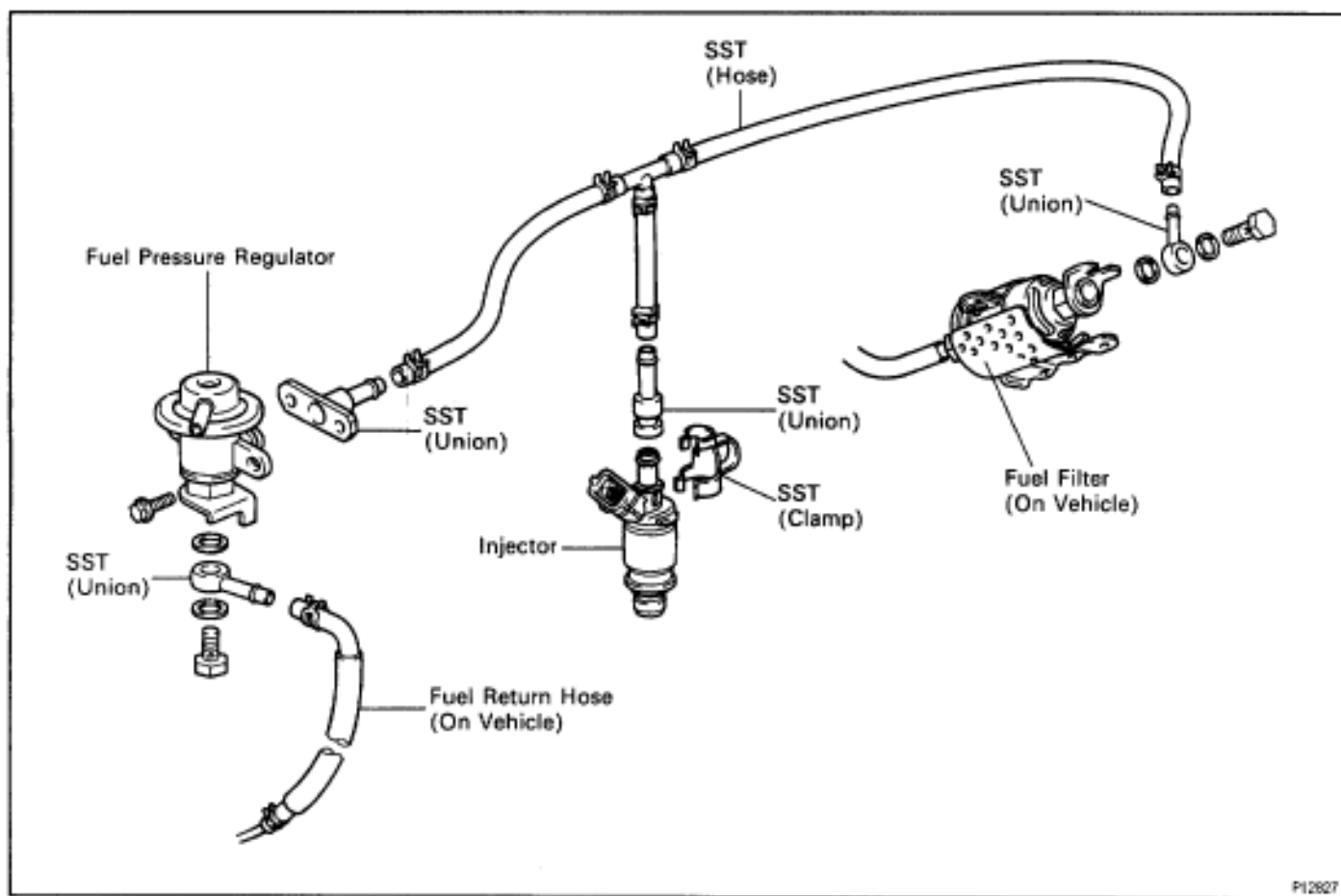

- (a) Remove the union bolt and 2 gaskets, and disconnect the fuel inlet hose from the fuel filter outlet.

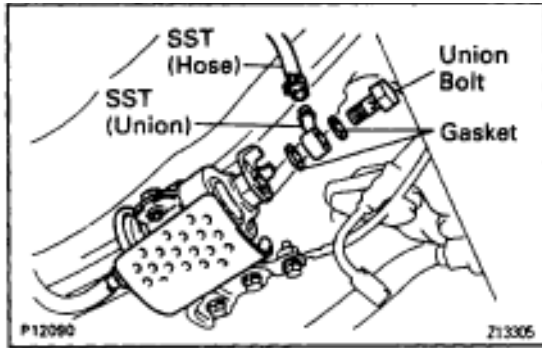

- (b) Connect SST (hose) to the fuel filter outlet with SST (union), the 2 gaskets and union bolt.
 SST 09268-41045 (90405-09015)
Torque: 29 N·m (300 kgf·cm, 22 ft·lbf)

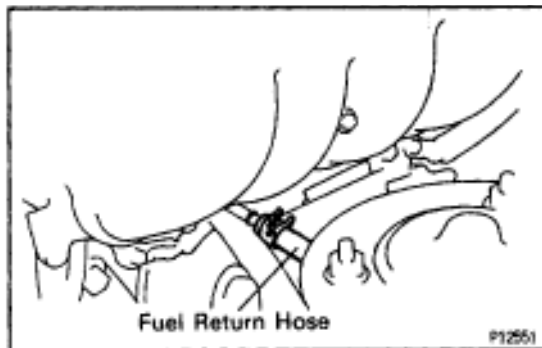

- (c) Disconnect the fuel return hose from the fuel return pipe.
 (d) Remove the fuel pressure regulator from the delivery pipe.
 (See step 3 in fuel pressure regulator removal)

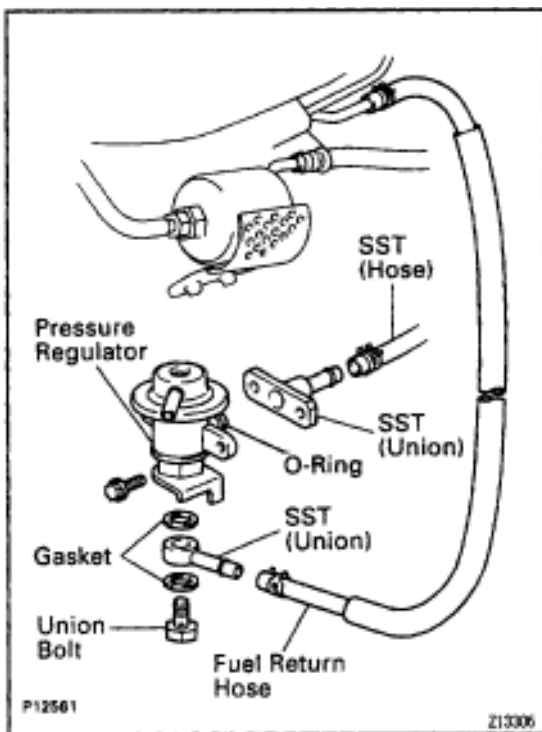

- (e) Install the O-ring to the fuel inlet of the pressure regulator.
 (f) Connect SST (hose) to the fuel inlet of the pressure regulator with SST (union) and the 2 bolts.
 SST 09268-41045 (09268-41090)
 (g) Connect the fuel return hose to the fuel outlet of the pressure regulator with SST (union), the 2 gaskets and union bolt.
 SST 09268-41045 (09268-41070)

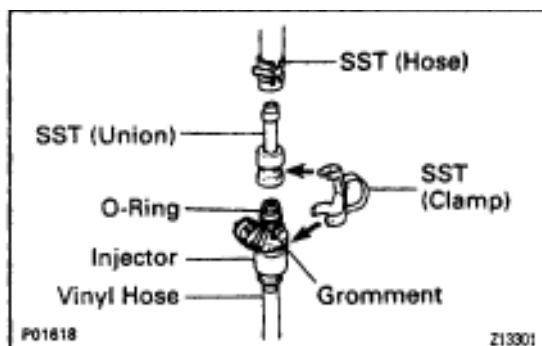

- (h) Install the grommet and O-ring to the injector.
 (i) Connect SST (hose) to the injector with SST (union), and hold the injector and union with SST (clamp).
 SST 09268-41045
 (j) Put the injector into the graduated cylinder.
 HINT: Install a suitable vinyl hose onto the injector to prevent gasoline from splashing out.

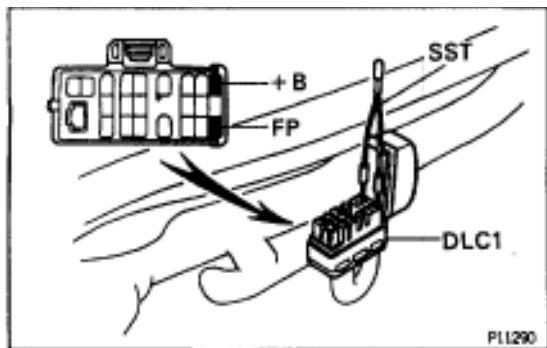

- (k) Using SST, connect terminals +B and FP of the DLC 1.
SST 09843-18020
 - (l) Reconnect the negative (-) terminal cable to the battery.
 - (m) Turn the ignition switch ON.
- NOTICE: Do not start the engine.**

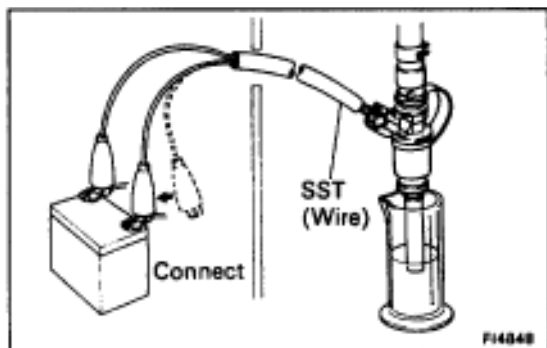

- (n) Connect SST (wire) to the injector and battery for 15 seconds, and measure the injection volume with a graduated cylinder. Test each injector 2 or 3 times.
SST 09842-30070
- Injection volume:**
70-88 cm³ (4.3-5.4 cu in.) per 15 sec.
- Difference between each injector:**
9 cm³ (0.5 cu in.) or less
- If the injection volume is not as specified, replace the injector.

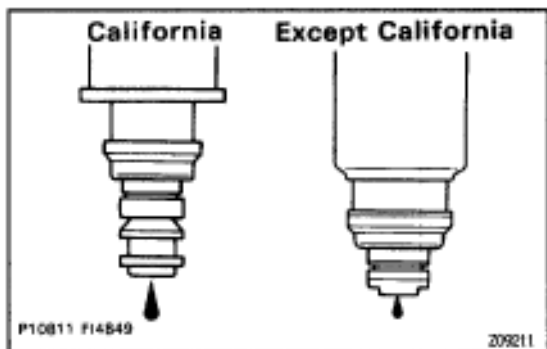

2. INSPECT LEAKAGE

- (a) In the condition above, disconnect the tester probes of SST (wire) from the battery and check the fuel leakage from the injector.
SST 09842-30070
- Fuel drop:**
One drop or less per minute
- (b) Disconnect the negative (-) terminal cable from the battery.
 - (c) Remove the SST.
SST 09268-41045 and 09843-18020
 - (d) Reconnect the fuel inlet hose to the fuel filter with 2 new gaskets and union bolt.
Torque: 29 N·m (300 kgf·cm, 22 ft·lbf)
 - (e) Reconnect the fuel return hose to the fuel return pipe.
 - (f) Reinstall the fuel pressure regulator to the delivery pipe. (See step 1 in fuel pressure regulator installation)

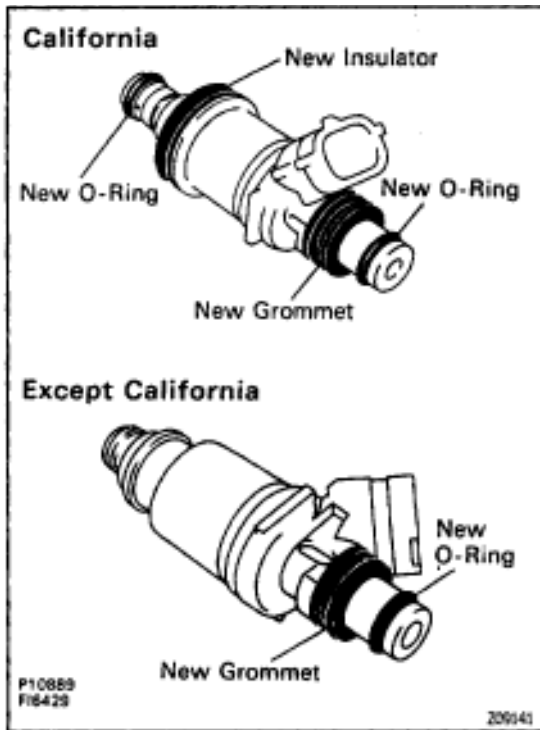

INJECTORS INSTALLATION

1. INSTALL INJECTORS AND DELIVERY PIPE

- (a) California:
Install new insulator and grommet to each injector.
- (b) Except California:
Install a new grommet to each injector.
- (c) California:
Apply a light coat of gasoline to 2 new O-rings, and install them to each injector.
- (d) Except California:
Apply a light coat of gasoline to a new O-ring, and install it to each injector.

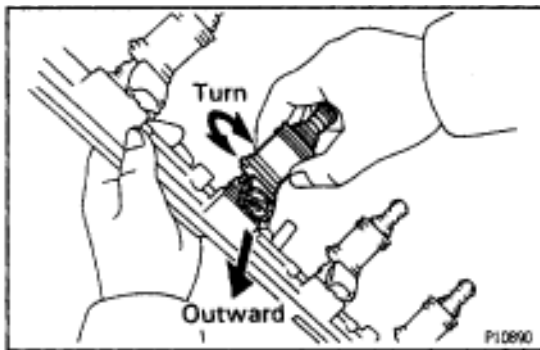

- (e) While turning the injector clockwise and counterclockwise, push it to the delivery pipe. Install the 6 injectors.
- (f) Position the injector connector outward.

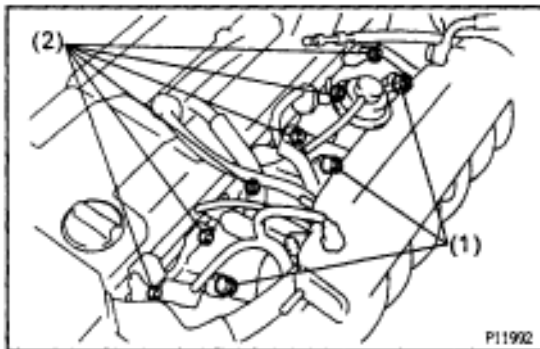

- (g) Install these parts to the intake manifold:
 - (1) 3 spacers
 - (2) Except California:
6 new insulators

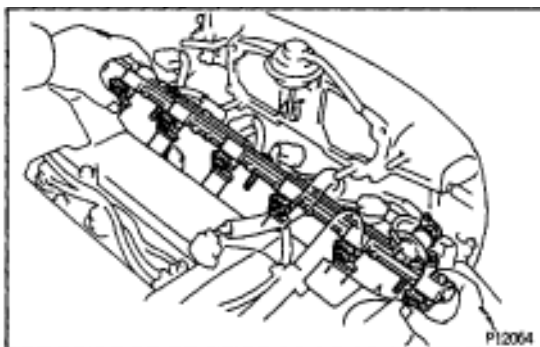

- (h) Install the 3 bolts to the delivery pipe.
- (i) California:
Apply a light coat of gasoline to O-ring on each injector.
- (j) Attach the 6 injectors together with the delivery pipe to the intake manifold.



- (k) Temporarily install the 3 bolts holding the delivery pipe to the intake manifold.

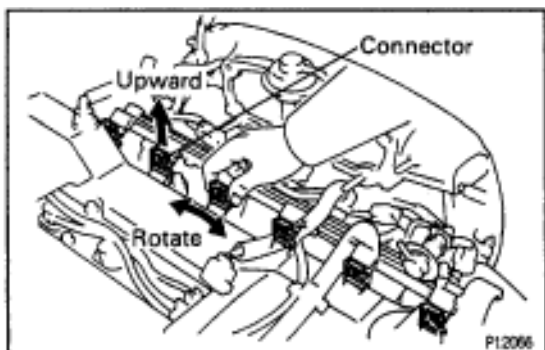

- (l) Check that the injectors rotate smoothly.
HINT: If injectors do not rotate smoothly, the probable cause is incorrect installation of O-rings. Replace the O-rings.
- (m) Position the injector connector upward.

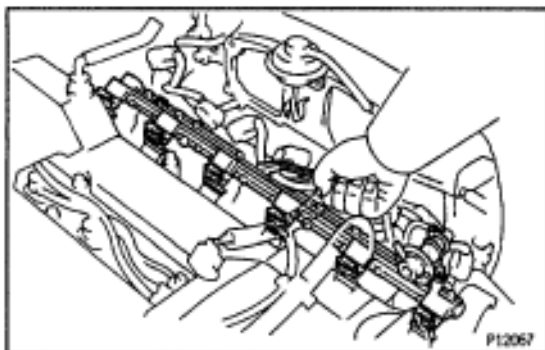

- (n) Tighten the 3 bolts holding the delivery pipe to the intake manifold.

Torque: 21 N·m (210 kgf·cm, 15 ft·lbf)

2. INSTALL ACTUATOR FOR ACIS

- (a) Install the actuator with the 2 bolts.

Torque: 6.8 N·m (70 kgf·cm, 61 in·lbf)

- (b) Inspect the intake air control valve.
(See intake air control valve inspection in ACIS)

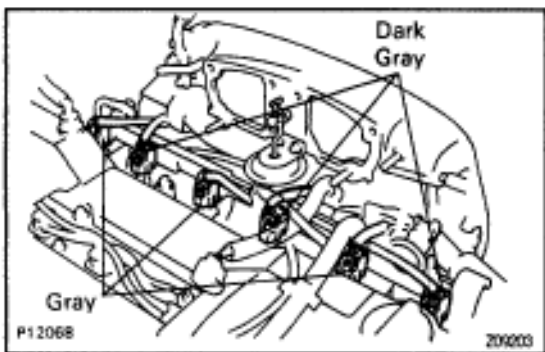

3. CONNECT INJECTOR CONNECTORS

Connect the 6 injector connectors.

HINT: The No.1, No.3 and No.5 injector connectors are dark gray, and the No.2, No.4 and No.6 injector connectors are gray.

4. CONNECT FUEL INLET PIPE TO DELIVERY PIPE

Connect the inlet pipe with 2 new gaskets and the union bolt.

Torque: 41 N·m (420 kgf·cm, 30 ft·lbf)

5. CONNECT FUEL RETURN PIPE TO FUEL PRESSURE REGULATOR

Connect the return pipe with 2 new gaskets and the union bolt.

Torque: 27 N·m (280 kgf·cm, 20 ft·lbf)

6. **Except California:**
CONNECT VACUUM SENSING HOSE TO FUEL PRESSURE REGULATOR

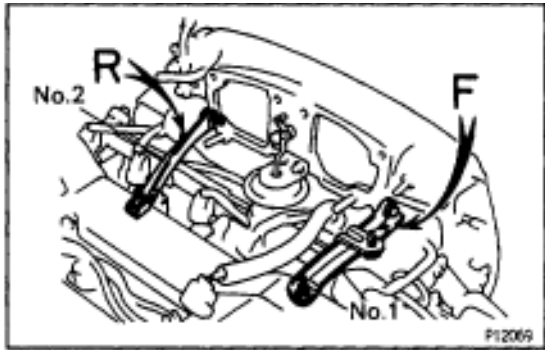

7. INSTALL AIR INTAKE CHAMBER STAYS

HINT: The No.1 stay is marked with "F", and No.2 stay is marked with "R".

- (a) Install the No.1 stay with the bolt and nut.
Torque: 18 N·m (185 kgf·cm, 13 ft·lbf)
- (b) Install the No.2 stay with the bolt and nut.
Torque: 18 N·m (185 kgf·cm, 13 ft·lbf)

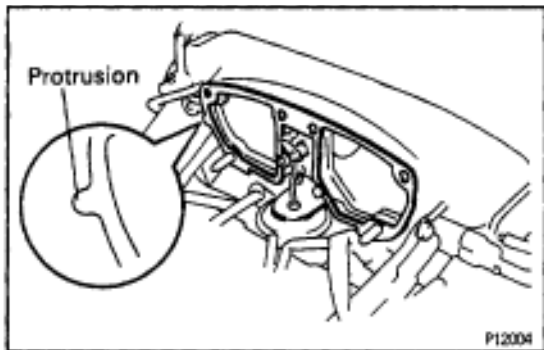

8. INSTALL THROTTLE BODY AND INTAKE AIR CONNECTOR ASSEMBLY

- (a) Install a new gasket to the air intake chamber, facing the protrusion rearward.
- (b) Place the throttle body and intake air connector assembly on the cylinder head.
- (c) Connect these hoses:
 - 3 vacuum hoses (from No.2 vacuum pipe) to No.1 vacuum pipe
 - Water bypass hose (from water outlet) to throttle body
 - Vacuum hose (from actuator for ACIS) to No.1 vacuum pipe
- (d) Install the 4 bolts and 2 nuts holding the intake air connector to the air intake chamber.
Torque: 27 N·m (270 kgf·cm, 20 ft·lbf)
- (e) Install the nut holding the VSV for the ACIS to the air intake chamber.
- (f) Connect these connectors and hoses:
 - Throttle position sensor connector
 - IAC valve connector
 - VSV connector for EGR
 - PCV hose to intake air connector
 - Water bypass hose (from No.2 water bypass pipe) to throttle body
 - California only:
Air hose to IAC valve

9. INSTALL THROTTLE BODY BRACKET

Torque: 21 N·m (210 kgf·cm, 15 ft·lbf)

10. INSTALL NO.2 VACUUM PIPE

Torque: 27 N·m (270 kgf·cm, 20 ft·lbf)

11. CONNECT EGR GAS TEMPERATURE SENSOR CONNECTOR

12. INSTALL EGR PIPE

- (a) Temporarily install the union nut of the EGR pipe.
- (b) Install a new gasket and the EGR pipe to the cylinder head with the 2 bolts.
Torque: 27 N·m (270 kgf·cm, 20 ft·lbf)
- (c) Tighten the union nut of the EGR pipe.

Torque: 64 N·m (650 kgf·cm, 47 ft·lbf)

13. California only:
INSTALL VSV FOR FUEL PRESSURE CONTROL
14. INSTALL INTAKE AIR CONNECTOR PIPE
15. CONNECT CONTROL CABLES TO THROTTLE BODY
16. FILL WITH ENGINE COOLANT
17. CHECK FOR FUEL LEAKS
(See item 5 in fuel system in precaution)

FUEL PRESSURE PULSATION DAMPER COMPONENTS FOR REMOVAL AND INSTALLATION

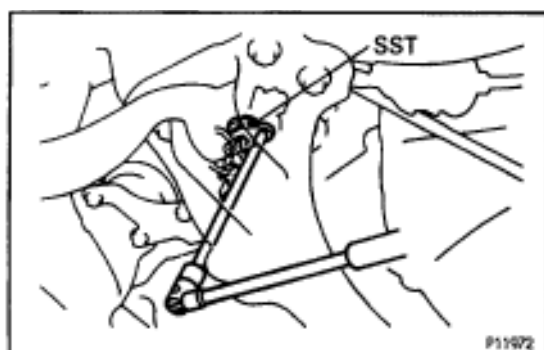
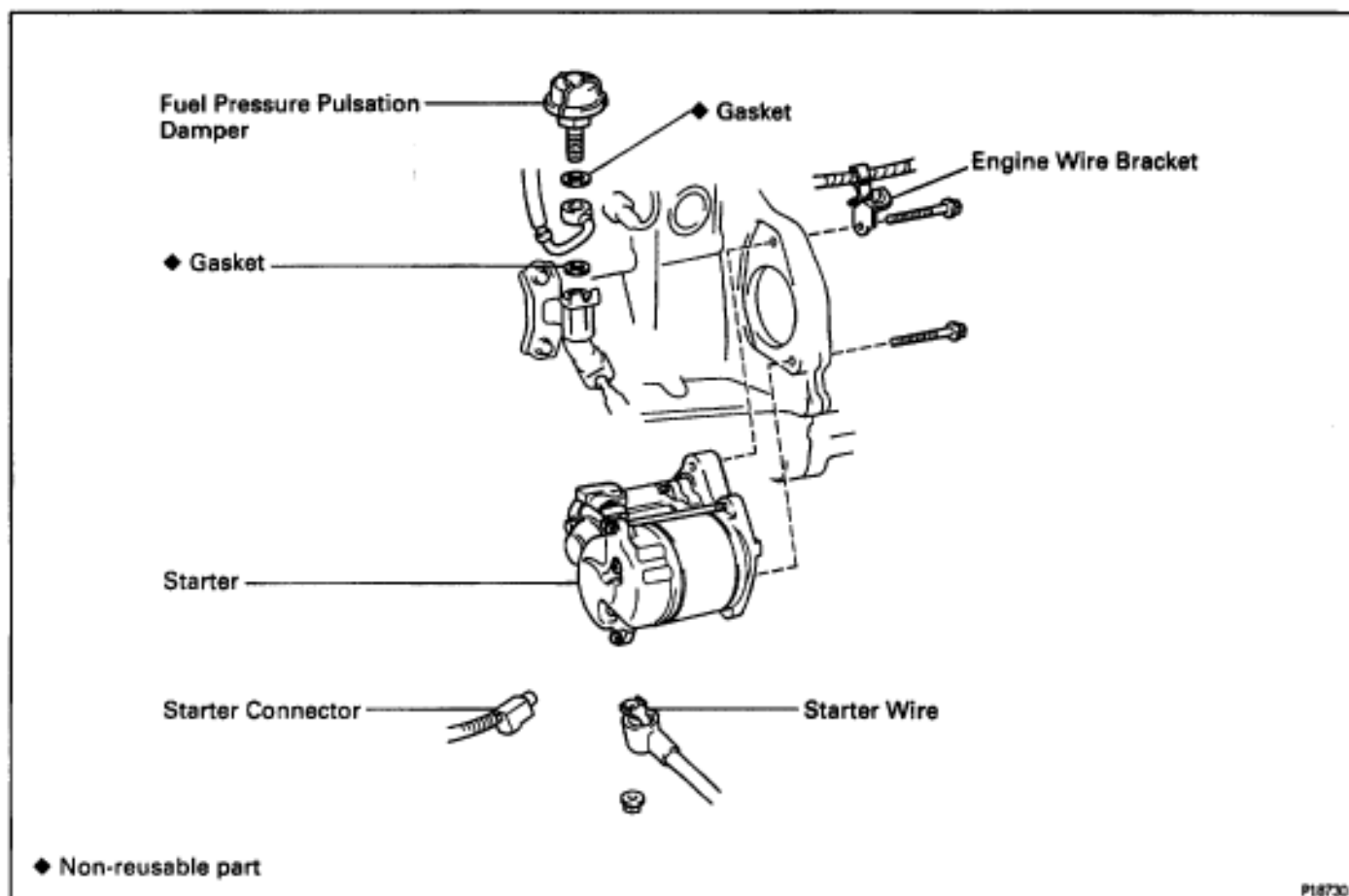

FUEL PRESSURE PULSATION DAMPER REMOVAL

1. REMOVE STARTER
(See starter removal in Starting System)
2. REMOVE FUEL PRESSURE PULSATION DAMPER
 - (a) Remove the pulsation damper and upper gasket.
 - (b) Disconnect the fuel inlet pipe from the fuel pipe support, and remove the lower gasket.

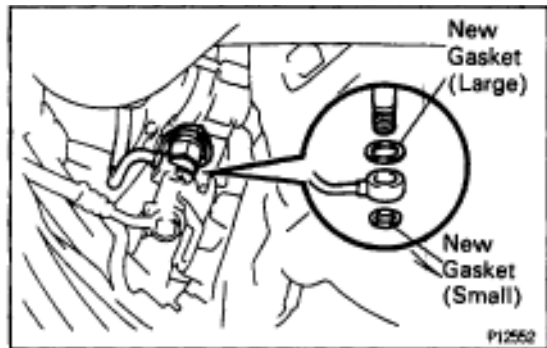

FUEL PRESSURE PULSATION DAMPER INSTALLATION

1. INSTALL FUEL PRESSURE PULSATION DAMPER

- (a) Install the fuel inlet pipe and pulsation damper with 2 new gaskets.

HINT: Different sized gaskets are used for the upper (large size) and lower (small size).

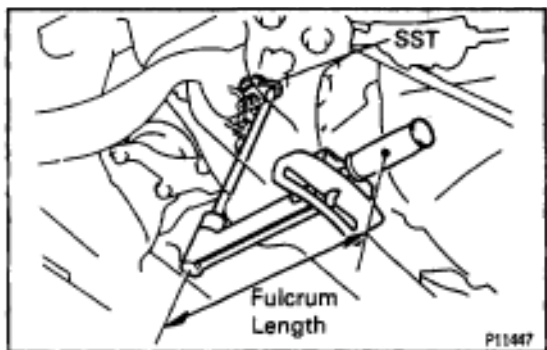

- (b) Using SST, tighten the pulsation damper.

SST 09612-24014 (09617-24011)

Torque:

41 N·m (420 kgf·cm, 30 ft·lbf)

35 N·m (350 kgf·cm, 25 ft·lbf) for SST

HINT: Use a torque wrench with a fulcrum length of 30 cm (11.81 in.).

2. INSTALL STARTER

(See starter installation in Starting System)

4. CHECK FOR FUEL LEAKS

(See item 5 in fuel system in precaution)

FUEL TANK AND LINE COMPONENTS

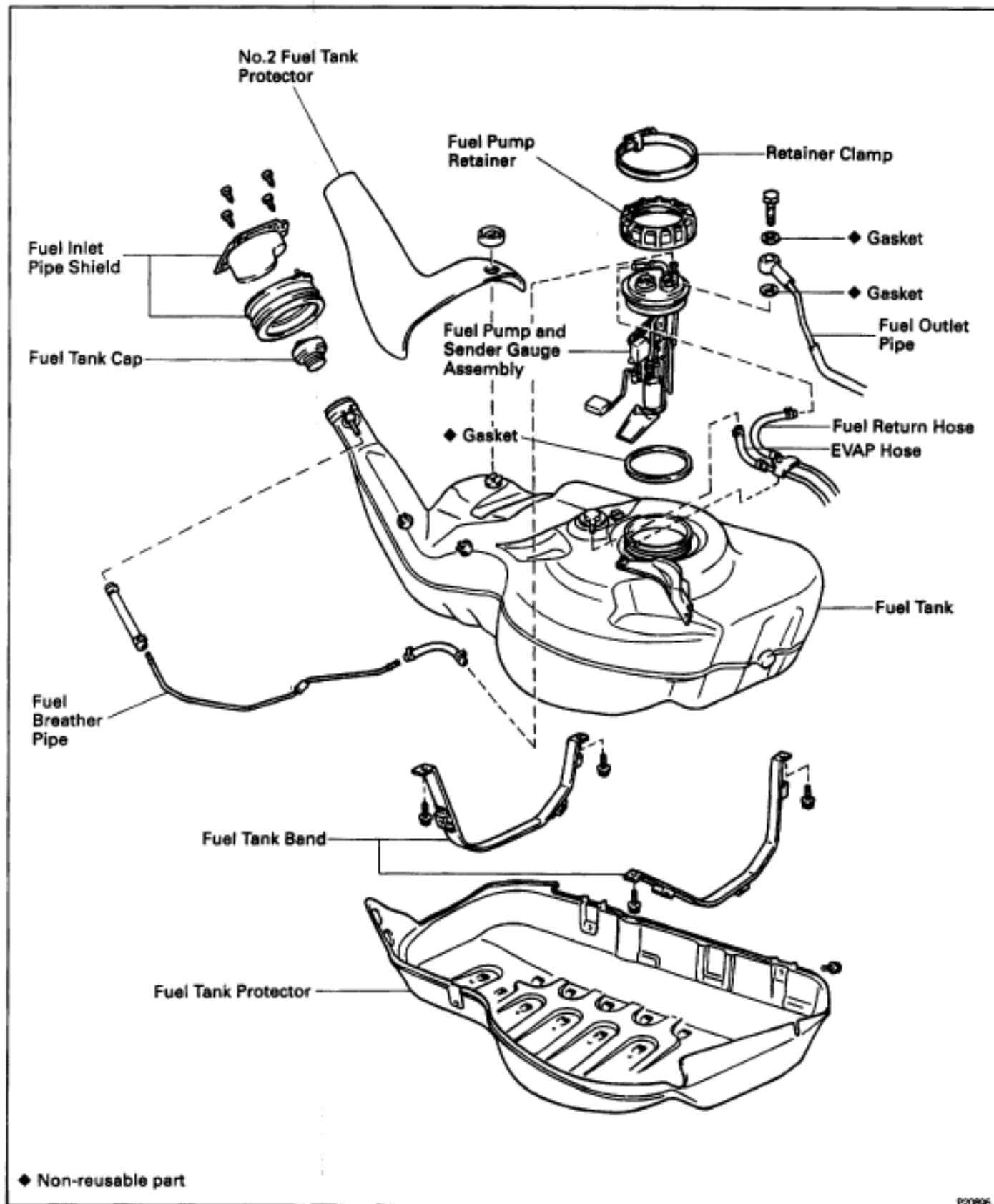

PRECAUTIONS

1. Always use new gaskets when replacing the fuel tank or component parts.
2. Apply the proper torque to all parts tightened.

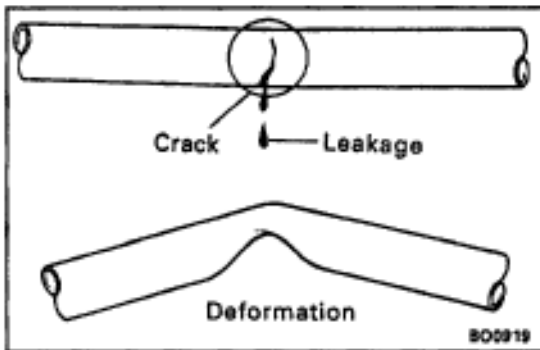

FUEL LINES AND CONNECTIONS INSPECTION

- (a) Check the fuel lines for cracks or leakage, and all connections for deformation.
- (b) Check the fuel tank vapor vent system hoses and connections for looseness, sharp bends or damage.
- (c) Check the fuel tank for deformation, cracks, fuel leakage or tank band looseness.
- (d) Check the filler neck for damage or fuel leakage.
- (e) Hose and tube connections are as shown in the illustration. If a problem is found, repair or replace the part as necessary.

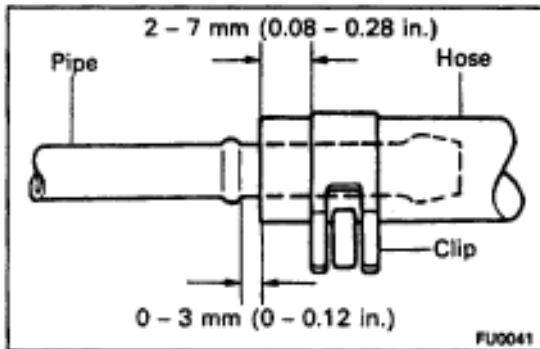
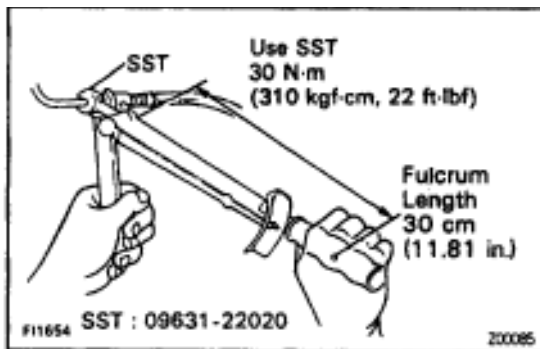

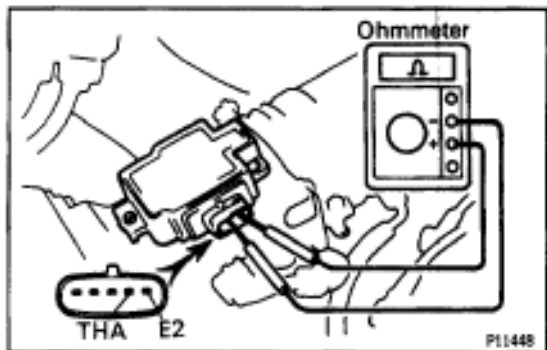

VOLUME AIR FLOW (VAF) METER ON-VEHICLE INSPECTION

INSPECT VAF METER RESISTANCE

- Disconnect the VAF meter connector.
- Using an ohmmeter, measure the resistance between terminals THA and E2.

Between terminals	Resistance	Temperature
THA-E2	10-20 k Ω	-20°C (-4°F)
THA-E2	4-7 k Ω	0°C (32°F)
THA-E2	2-3 k Ω	20°C (68°F)
THA-E2	0.9-1.3 k Ω	40°C (104°F)
THA-E2	0.4-0.7 k Ω	60°C (140°F)

If the resistance is not as specified, replace the VAF meter.

- Reconnect the VAF meter connector.

COMPONENTS FOR REMOVAL AND INSTALLATION

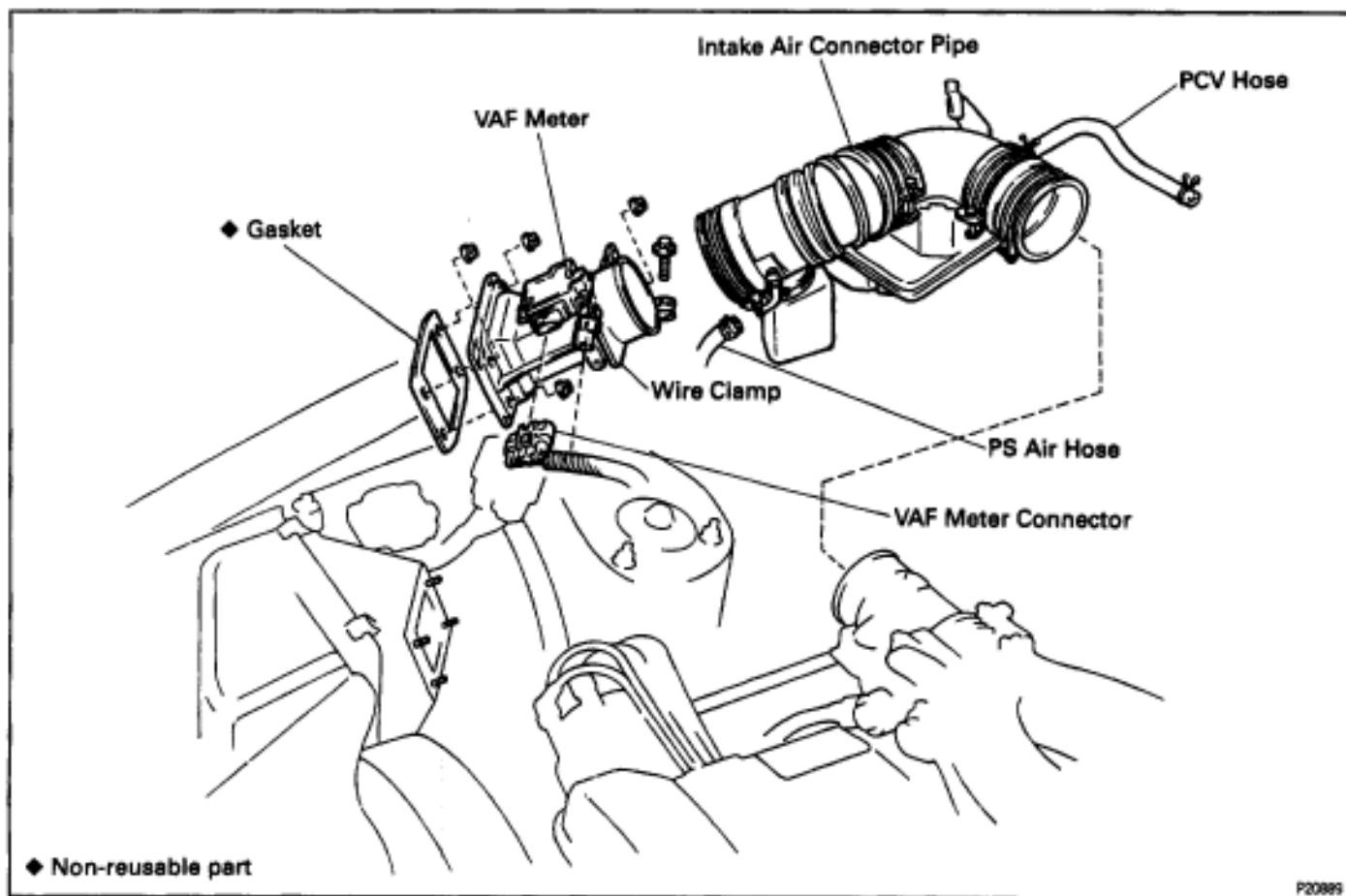

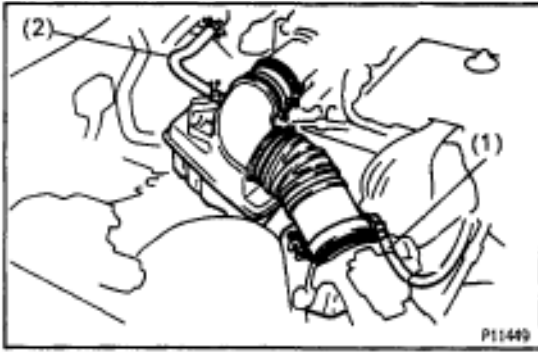

VAF METER REMOVAL

Installation is in the reverse order of removal.

1. REMOVE INTAKE AIR CONNECTOR PIPE

- (a) Disconnect these hoses:
 - (1) PS air hose from air connector pipe
 - (2) PCV hose from No.2 cylinder head cover
- (b) Loosen the 2 hose clamps, and remove the air connector pipe together with the hoses.

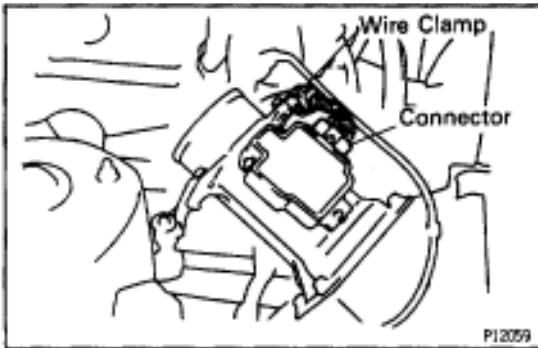

2. REMOVE VAF METER

- (a) Disconnect the VAF meter connector.
- (b) Disconnect the VAF meter wire from the wire clamp on the bracket.

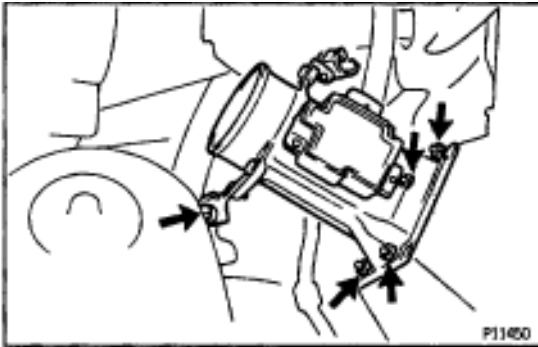

- (c) Remove the 4 nuts, bolt, VAF meter and gasket.
Torque: 10 N·m (100 kgf·cm, 7 ft·lbf)

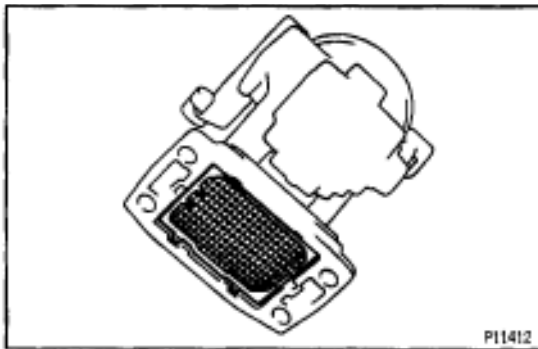

VAF METER INSPECTION

INSPECT VAF METER

Check that the honeycomb is neither deformed nor damaged.

If necessary, replace the VAF meter.



THROTTLE BODY ON-VEHICLE INSPECTION

Throttle Body

INSPECT THROTTLE BODY

(a) Check that the throttle linkage moves smoothly.

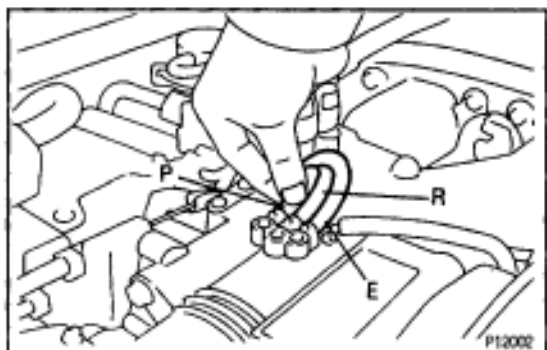

(b) Check the vacuum at each port.

- Start the engine.
- Check the vacuum with your finger.

Port name	At idle	At 3,000 rpm
P	No vacuum	Vacuum
E	No vacuum	Vacuum
R	No vacuum	Vacuum

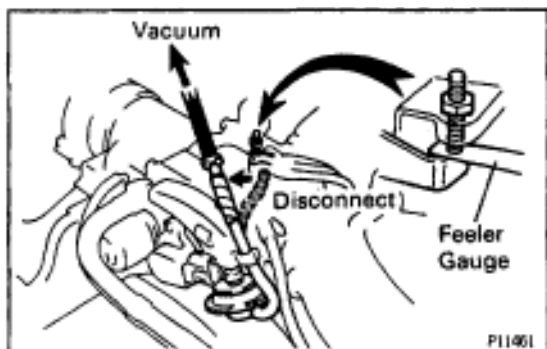

Throttle Position Sensor

INSPECT THROTTLE POSITION SENSOR

(a) Disconnect the throttle position sensor connector.

(b) Disconnect the throttle opener vacuum hose from the throttle body.

(c) Apply vacuum to the throttle opener.

(d) Insert a feeler gauge between the throttle stop screw and stop lever.

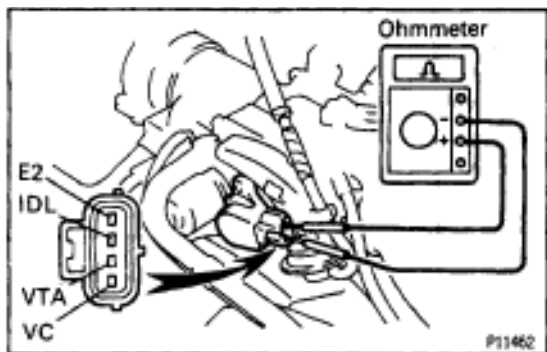

(e) Using an ohmmeter, measure the resistance between each terminal.

Clearance between Lever and stop screw	Between terminals	Resistance
0 mm (0 in.)	VTA-E2	0.34-6.3 k Ω
0.40 mm (0.016 in.)	IDL-E2	0.5 k Ω or less
0.60 mm (0.024 in.)	IDL-E2	Infinity
Throttle valve fully Open	VTA-E2	2.4-11.2 k Ω
-	VC-E2	3.1-7.2 k Ω

(f) Reconnect the throttle position sensor connector.

(g) Reconnect the throttle opener vacuum hose to the throttle body.

Dashpot

1. WARM UP ENGINE

Allow the engine to warm up to normal operating temperature.

2. CHECK IDLE SPEED

Idle speed (Transmission in neutral position):

700 ± 50 rpm

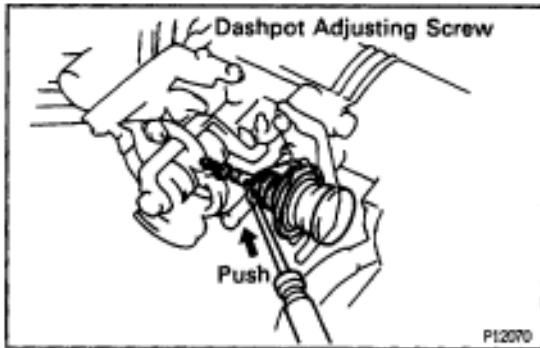

3. CHECK AND ADJUST DASHPOT SETTING SPEED

- Disconnect the control cables from the throttle body.
- Push the dashpot push rod all the way with a screwdriver.
- Check that the dashpot is set.

Dashpot setting speed:

M/T

$2,600 \pm 400$

A/T

$1,800 \pm 400$ rpm

- Adjust the dashpot setting speed by turning the dashpot adjusting screw.
- Reconnect the control cables to the throttle body.

4. CHECK VTV OPERATION

- Maintain the engine speed at 3,500 rpm.
- Release the throttle valve, and check that the engine returns to idle in a few seconds.

Throttle Opener

1. WARM UP ENGINE

Allow the engine to warm up to normal operating temperature.

2. CHECK IDLE SPEED

Idle speed (Transmission in neutral position):

700 ± 50 rpm

3. CHECK THROTTLE OPENER SETTING SPEED

- Disconnect the throttle opener vacuum hose from the throttle body, and plug the throttle body port.
- Maintain the engine speed at 2,500 rpm.
- Release the throttle valve.
- Check that the throttle opener is set.

Throttle opener setting speed:

$1,500 \pm 400$ rpm

If the throttle opener setting speed is not as specified, replace the throttle body.

- Reconnect the throttle opener vacuum hose to the throttle body.

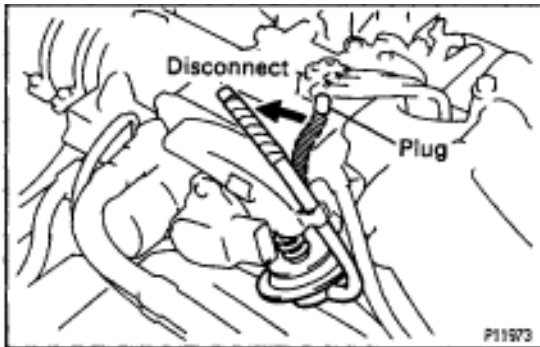

COMPONENTS FOR REMOVAL AND INSTALLATION

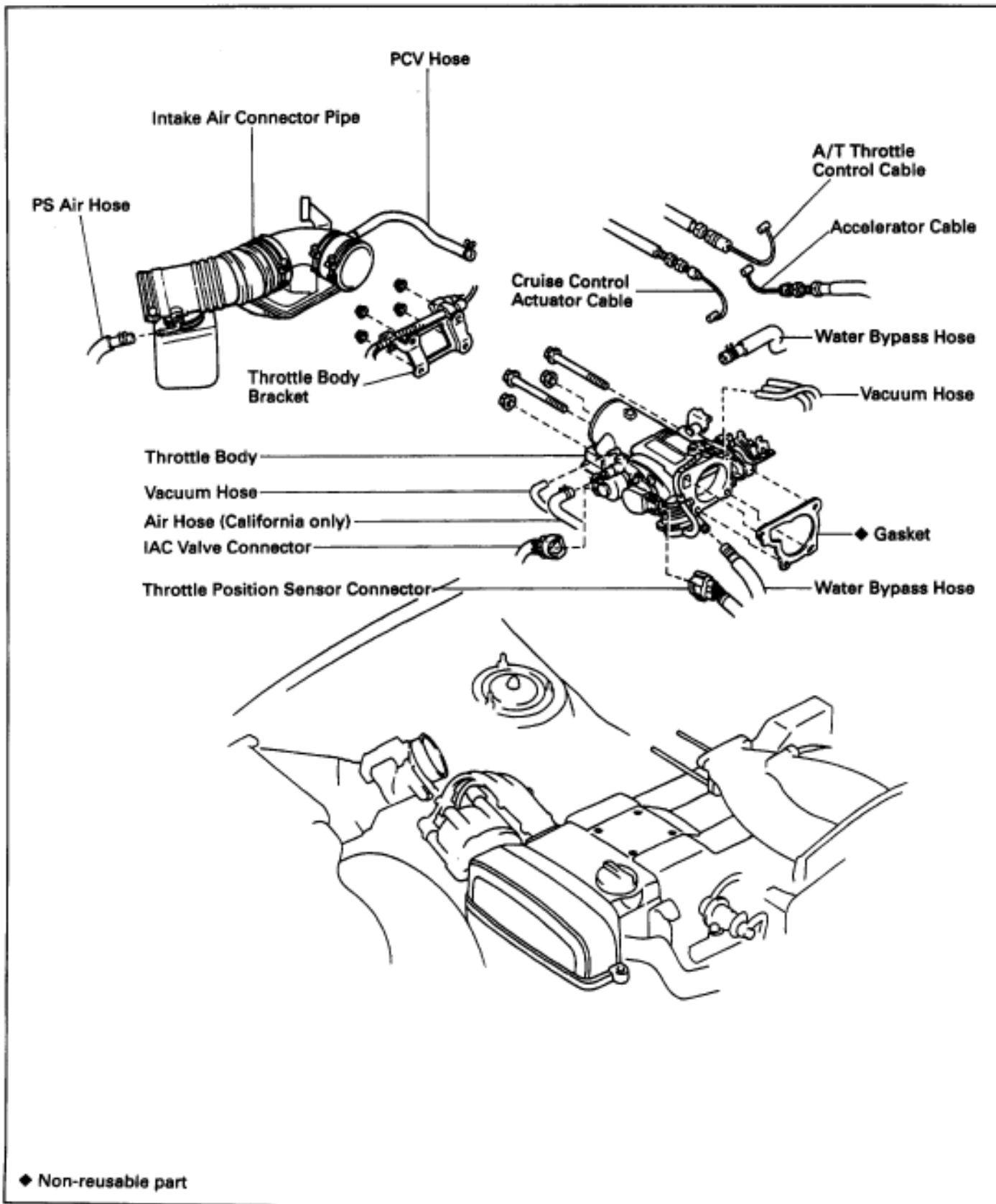

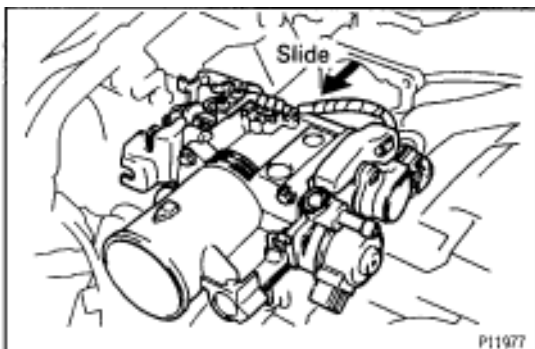
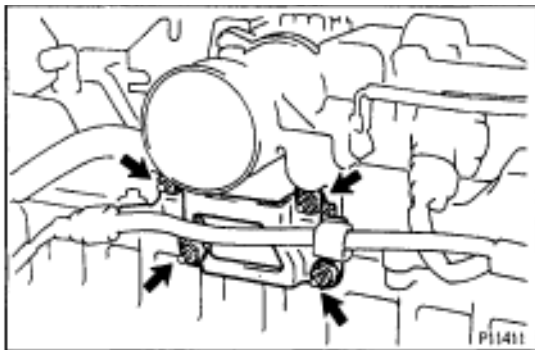
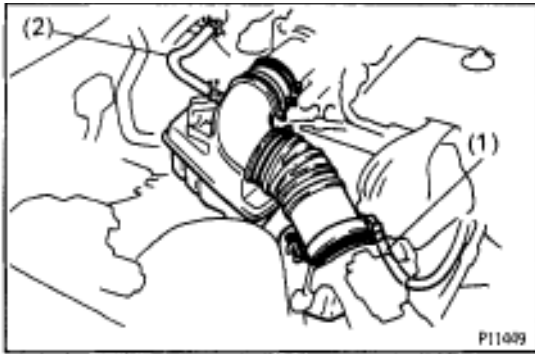

THROTTLE BODY REMOVAL

Installation is in the reverse order of removal.

1. **DRAIN ENGINE COOLANT**
2. **DISCONNECT CONTROL CABLES FROM THROTTLE BODY**

3. **REMOVE INTAKE AIR CONNECTOR PIPE**

(a) Disconnect these hoses:

- (1) PS air hose from air connector pipe
- (2) PCV hose from No.2 cylinder head cover

(b) Loosen the 2 hose clamps, and remove the air connector pipe together with the hoses.

4. **DISCONNECT THROTTLE BODY BRACKET FROM THROTTLE BODY AND CYLINDER HEAD**

Remove the 4 nuts, and disconnect the throttle body bracket from the throttle body and cylinder head.

Torque: 21 N·m (210 kgf·cm, 15 ft·lbf)

5. **REMOVE THROTTLE BODY**

(a) Disconnect these connectors and hoses from the throttle body:

- (1) Throttle position sensor connector
- (2) IAC valve connector
- (3) 4 vacuum hoses
- (4) California only:

Air hose (from intake manifold)

- (5) Water bypass hose (from No.2 water bypass pipe)

(b) Remove the 2 bolts and 2 nuts.

Torque: 21 N·m (210 kgf·cm, 15 ft·lbf)

(c) Slightly slide the throttle body away from the intake air connector.

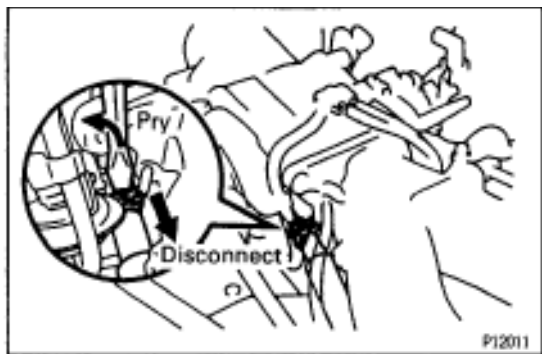

- (d) Disconnect the water bypass hose (from the water outlet) from the throttle body.
- (e) Remove the throttle body and gasket.
INSTALLATION HINT: Use a new gasket.

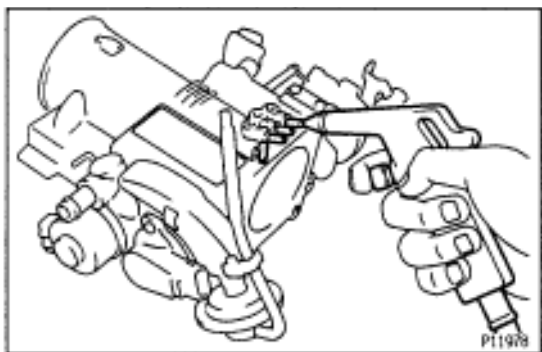

INSPECTION OF THROTTLE BODY

Throttle Body

1. CLEAN THROTTLE BODY

- (a) Using a soft brush and carburetor cleaner, clean the cast parts.
- (b) Using compressed air, clean all the passages and apertures.
NOTICE: To prevent deterioration, do not clean the throttle position sensor, dashpot and throttle opener.

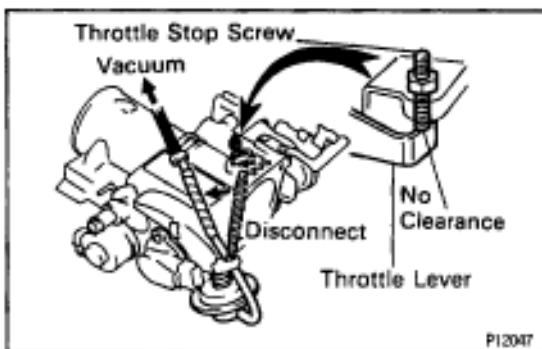

2. INSPECT THROTTLE VALVE

- (a) Disconnect the throttle opener vacuum hose from the throttle body.
- (b) Apply vacuum to the throttle opener.
- (c) Check that there is no clearance between the throttle stop screw and throttle lever when the throttle valve is fully closed.
- (d) Reconnect the throttle opener vacuum hose to the throttle body.

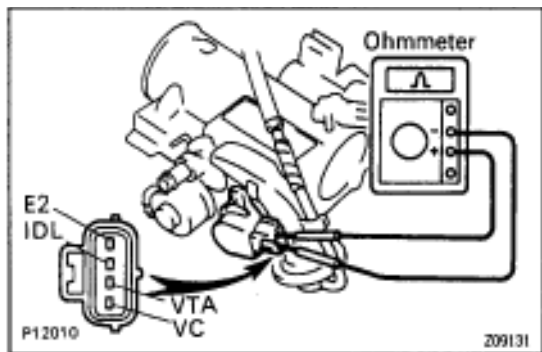

Throttle Position Sensor

1. INSPECT THROTTLE POSITION SENSOR (See on-vehicle inspection)

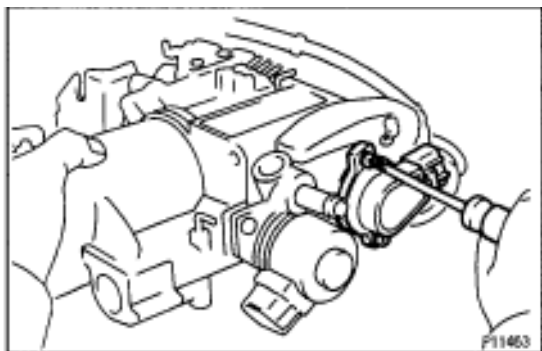

2. IF NECESSARY, ADJUST THROTTLE POSITION SENSOR

- (a) Loosen the 2 set screws of the sensor.

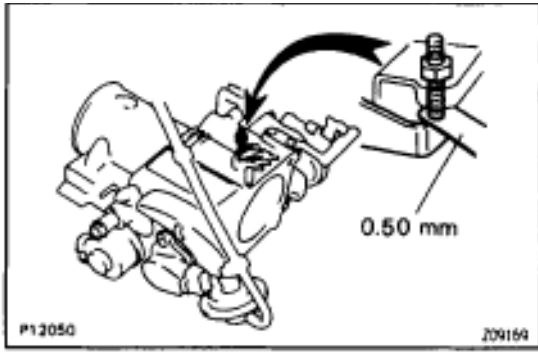

- (b) Insert a 0.50 mm (0.020 in.) feeler gauge between the throttle stop screw and stop lever.

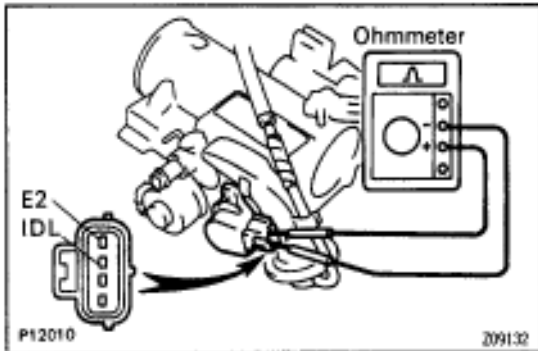

- (c) Connect the tester probe of an ohmmeter to the terminals IDL and E2 of the sensor.

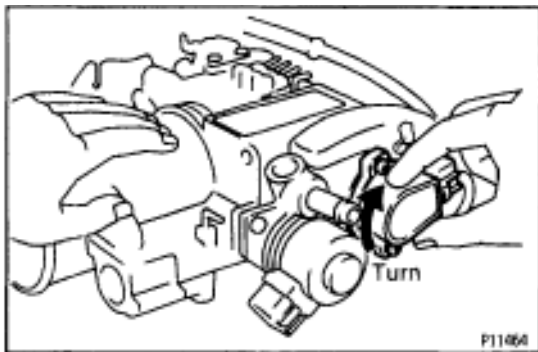

- (d) Gradually turn the sensor clockwise until the ohmmeter deflects, and secure it with the 2 set screws.

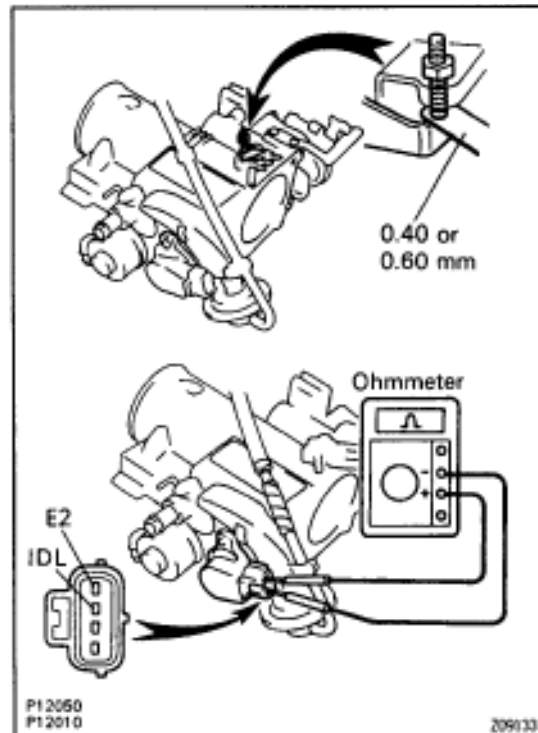

- (e) Recheck the continuity between terminals IDL and E2.

Clearance between lever and stop screw	Continuity (IDL-E2)
0.40 mm (0.016 in.)	Continuity
0.60 mm (0.024 in.)	No continuity

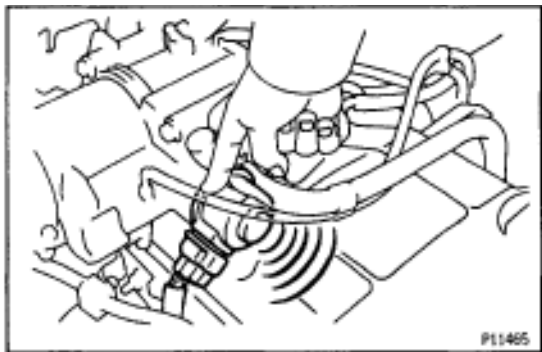

IDLE AIR CONTROL (IAC) VALVE ON-VEHICLE INSPECTION

1. INSPECT IAC VALVE FOR OPERATING SOUND

Check that there is a clicking sound immediately after stopping the engine.

If operation is not as specified, check the IAC valve, wiring and ECM.

2. California only: INSPECT AIR ASSIST SYSTEM

A. Warm up engine

Allow the engine to warm up to normal operating temperature.

B. Check idle speed

Idle speed (Transmission in neutral position):

700 ± 50 rpm

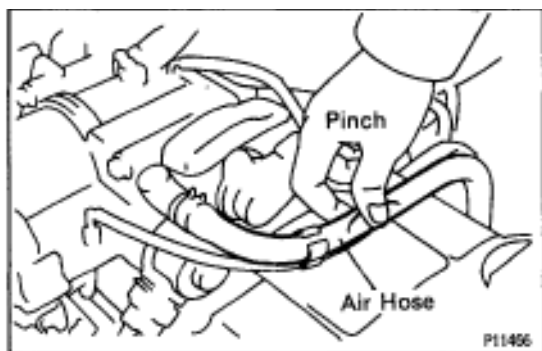

C. Check IAC valve operation

With engine idling, pinch the air hose and check that engine speed drops, and then returns back up to idle speed.

If operation is not as specified, check the IAC valve, wiring and ECM.

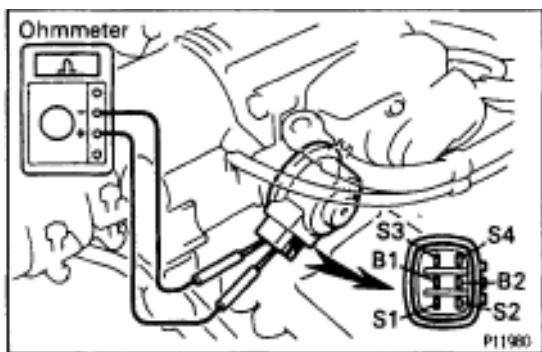

3. INSPECT IAC VALVE RESISTANCE

Using an ohmmeter, measure the resistance between the terminals (B1 (or B2) to others).

Resistance:

At 20°C (68°F) 18–22 Ω

If the resistance is not as specified, replace the IAC valve.

COMPONENTS FOR REMOVAL AND INSTALLATION

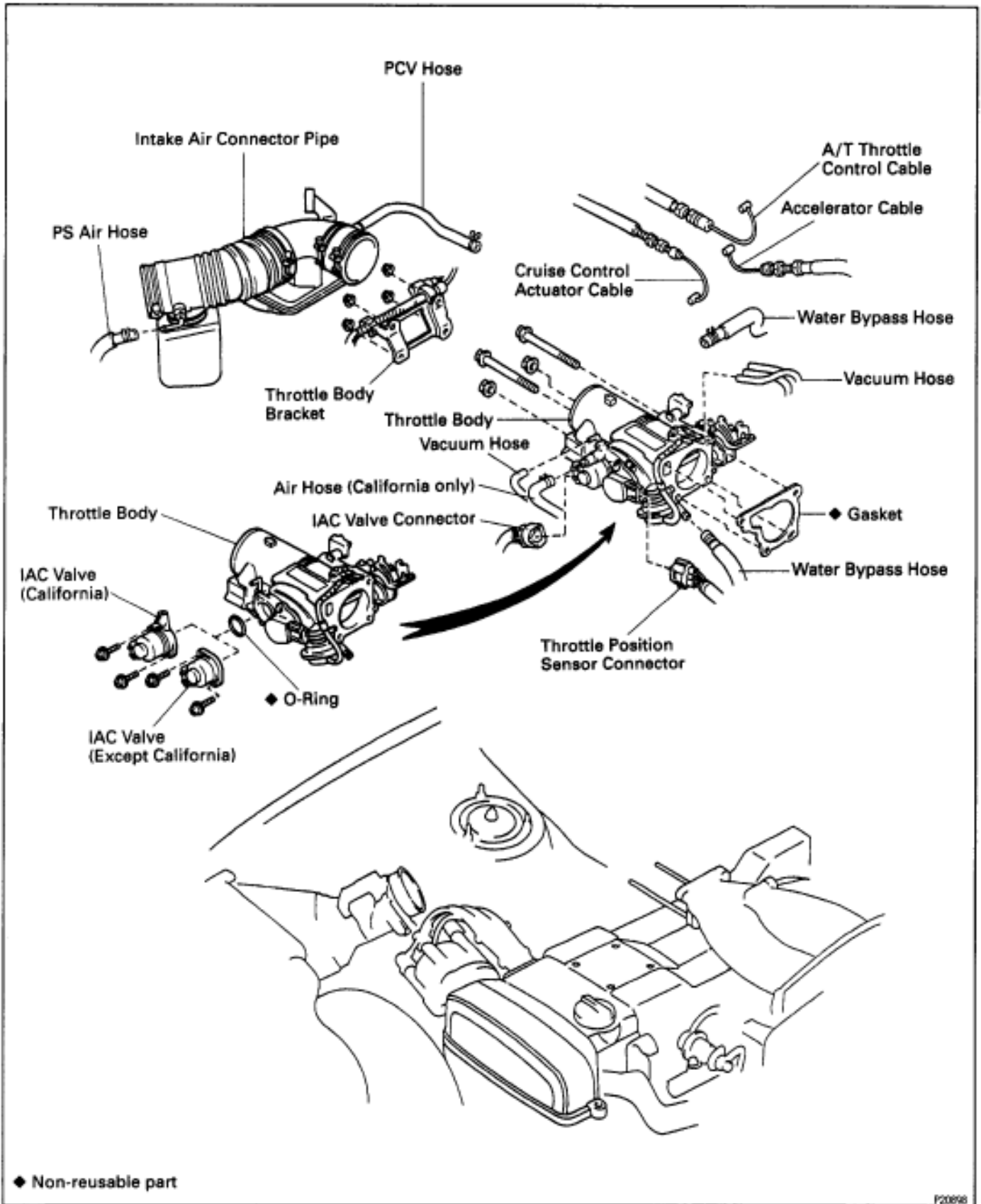

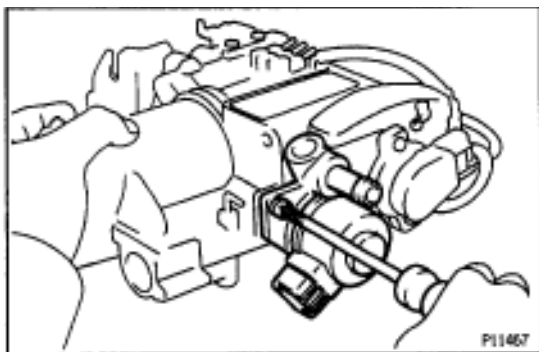

IAC VALVE REMOVAL

1. REMOVE THROTTLE BODY
(See throttle body removal)
2. REMOVE IAC VALVE FROM THROTTLE BODY
Remove the 2 screws, IAC valve and O-ring.

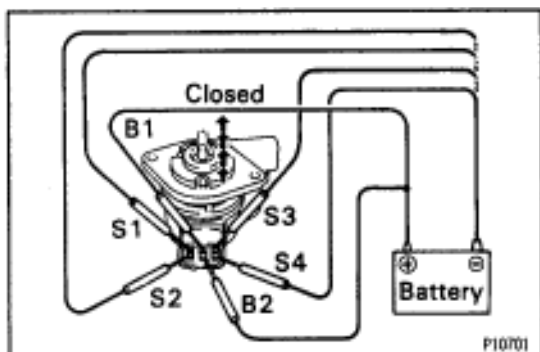

IAC VALVE INSPECTION

INSPECT IAC VALVE OPERATION

- (a) Apply battery voltage to terminals B1 and B2, and while repeatedly grounding S1-S2-S3-S4-S 1 in sequence, and check that the valve moves toward the closed position.

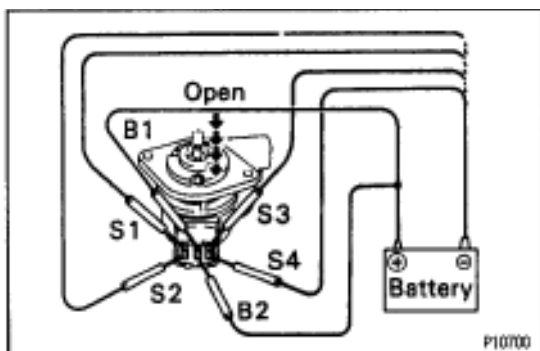

- (b) Apply battery voltage to terminals B1 and B2, and while repeatedly grounding S4-S3-S2-S1-S 4 in sequence, check that the valve moves toward the open position.
If operation is not as specified, replace the IAC valve.

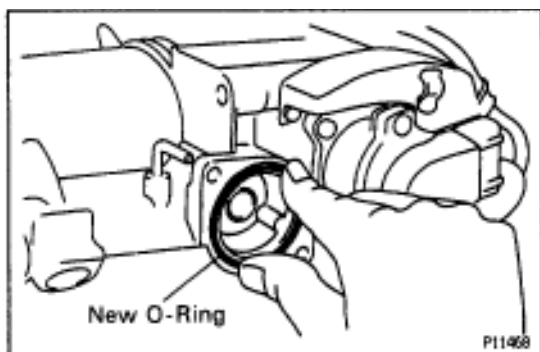

IAC VALVE INSTALLATION

1. INSTALL IAC VALVE TO THROTTLE BODY
 - (a) Install a new O-ring on the throttle body.
 - (b) Install the IAC valve with the 2 screws.
2. INSTALL THROTTLE BODY
(See throttle body installation)

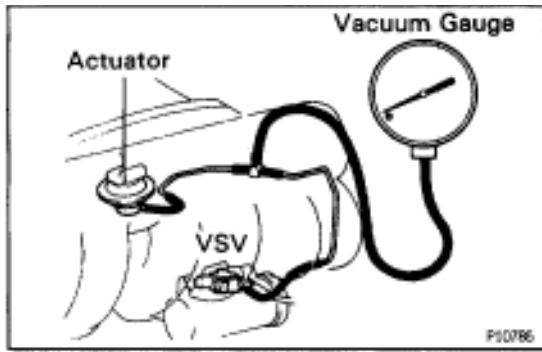

ACOUSTIC CONTROL INDUCTION SYSTEM (ACIS) ON-VEHICLE INSPECTION

1. CONNECT VACUUM GAUGE

Using a 3-way connector, connect vacuum gauge to the vacuum hose between the actuator and VSV.

2. START ENGINE

3. INSPECT ACIS

(a) While the engine is idling, check that the vacuum gauge needle does not move.

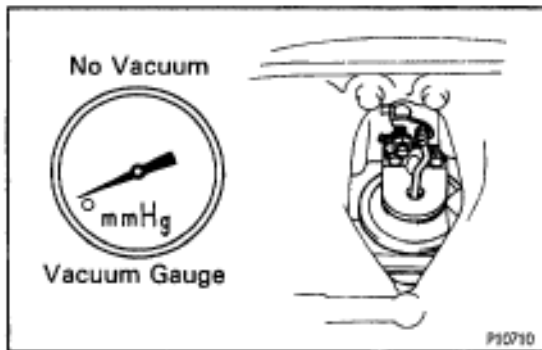

(b) Rapidly depress the accelerator pedal to fully open position and check that the vacuum gauge needle momentarily fluctuates approx. 33.3 kPa (250 mmHg, 9.84 in.Hg) or more. (The actuator rod is pulled down.) If operation is not as specified, check each part.

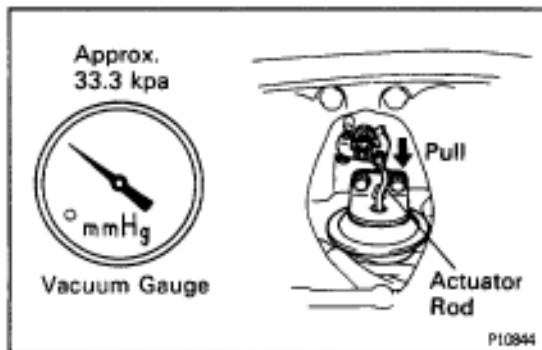

4. REMOVE VACUUM GAUGE

Remove the vacuum gauge, and reconnect the vacuum hose to their proper locations.

Vacuum Tank COMPONENTS FOR REMOVAL AND INSTALLATION

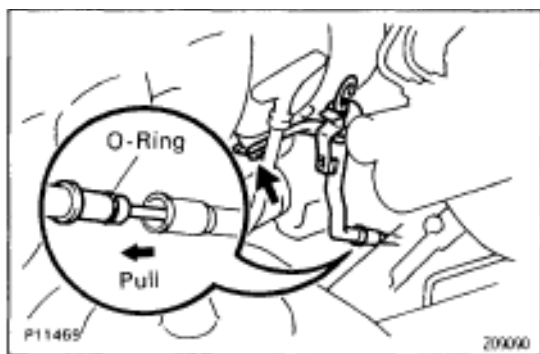
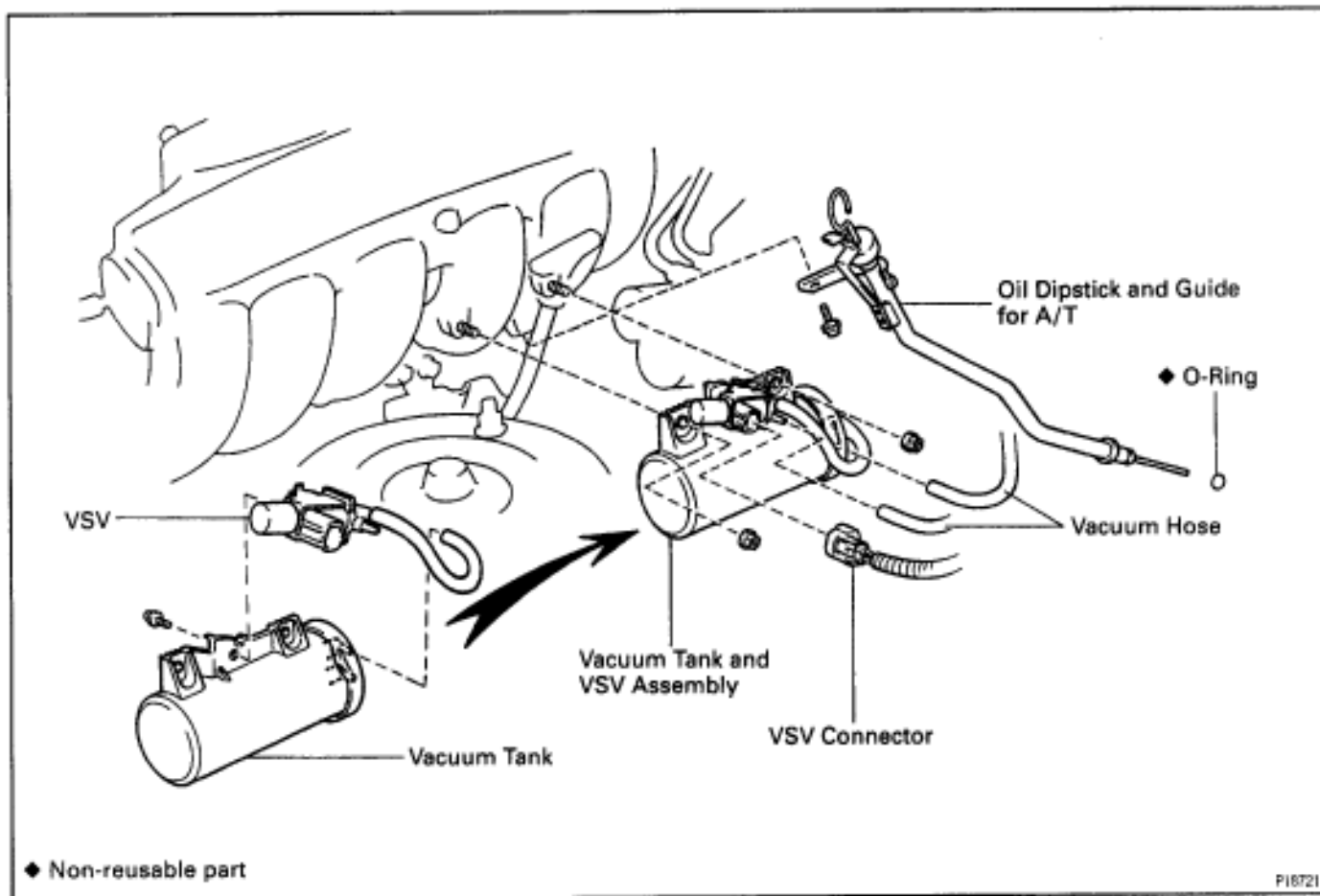

VACUUM TANK REMOVAL

Installation is in the reverse order of removal.

1. REMOVE OIL DIPSTICK AND GUIDE FOR A/T

- (a) Remove the bolt.
- (b) Pull out the dipstick guide together with the dipstick.
INSTALLATION HINT: Apply soapy water to the O-ring, and push in the dipstick guide.
- (c) Remove the O-ring from the dipstick guide.
INSTALLATION HINT: Use a new O-ring.

2. REMOVE VACUUM TANK AND VSV ASSEMBLY

- (a) Remove the 2 nuts, and disconnect the vacuum tank from the intake manifold.

Torque: 21 N·m (210 kgf·cm, 15 ft·lbf)

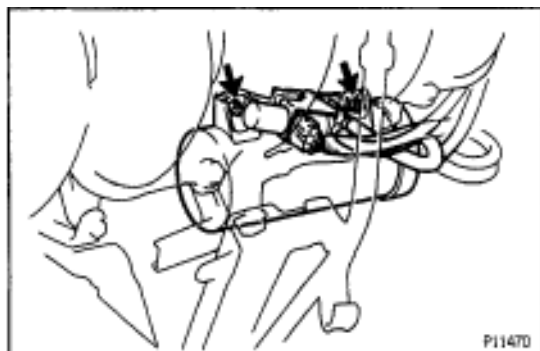

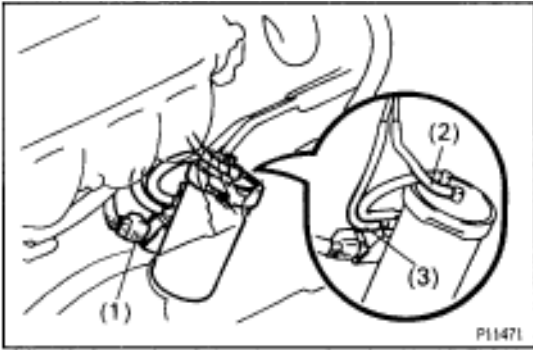

- (b) Disconnect the connector and hoses, and remove the vacuum tank and VSV assembly:
- (1) VSV connector
 - (2) Vacuum hose (from air intake chamber) from port B of vacuum tank
 - (3) Vacuum hose (from actuator) from VSV

3. REMOVE VSV FROM VACUUM TANK

- (a) Disconnect the vacuum hose from port A of the vacuum tank.
- (b) Remove the screw and VSV.

VACUUM TANK INSPECTION

INSPECT VACUUM TANK

- (a) Check that air flows from port A to B.

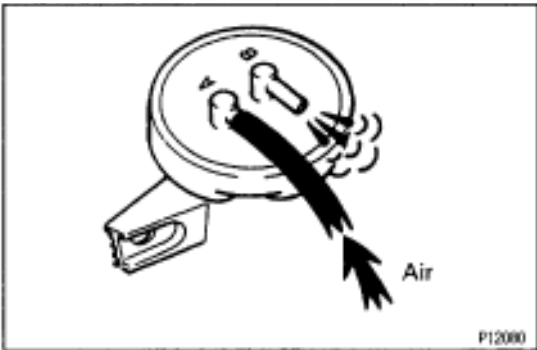

- (b) Check that air does not flow from port B to A.

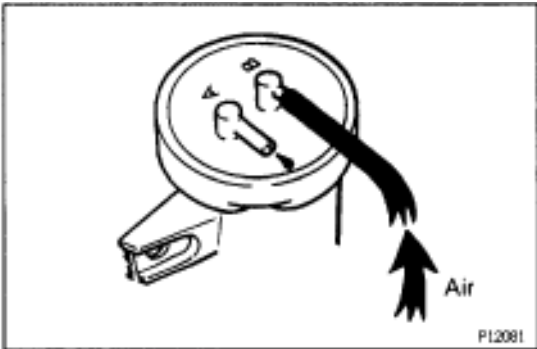

- (c) Plug port B with your finger, and apply 53.3 kPa (400 mmHg, 15.75 in.Hg) of vacuum to port A, and check that there is no change in vacuum after 1 minute.
If operation is not as specified, replace the vacuum tank.

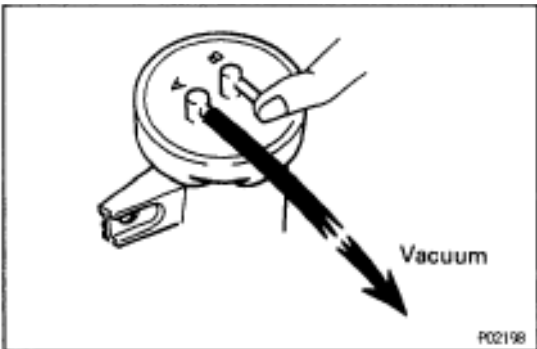

VSV INSPECTION

(See VSV for ACIS)

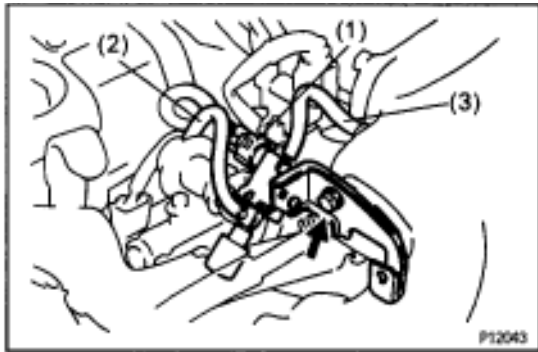

INTAKE AIR CONTROL VALVE REMOVAL

Installation is in the reverse order of removal.

1. REMOVE VSV FOR FUEL PRESSURE CONTROL

- (a) Disconnect the connector and hoses:
 - (1) VSV connector
 - (2) Vacuum sensing hose from fuel pressure control
 - (3) Vacuum sensing hose from air intake chamber

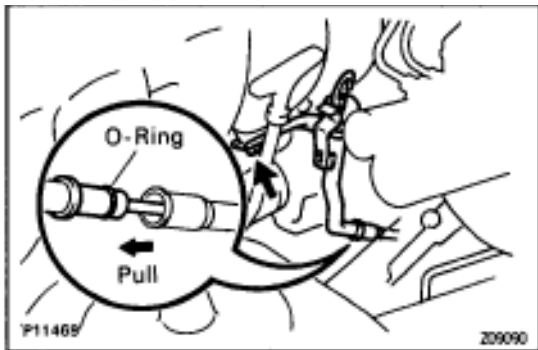

2. REMOVE OIL DIPSTICK AND GUIDE FOR A/T

- (a) Remove the bolt.
- (b) Pull out the dipstick guide together with the dipstick.
INSTALLATION HINT: Apply soapy water to the O-ring, and push in the dipstick guide.
- (c) Remove the O-ring from the dipstick guide.
INSTALLATION HINT: Use a new O-ring.

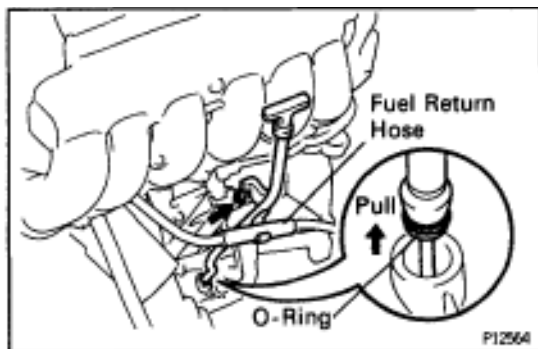

3. REMOVE OIL DIPSTICK AND GUIDE FOR ENGINE

- (a) Disconnect the fuel return hose from the clamp of the dipstick guide.
- (b) Remove the bolt.
- (c) Pull out the dipstick guide together with the dipstick.
INSTALLATION HINT: Apply soapy water to the O-ring, and push in the dipstick guide.
- (d) Remove the O-ring from the dipstick guide.
INSTALLATION HINT: Use a new O-ring.

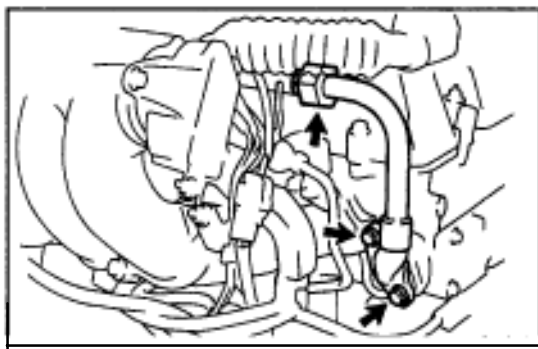

4. REMOVE EGR PIPE

- (a) Loosen the union nut of the EGR pipe.
Torque: 64 N·m (650 kgf·cm, 47 ft·lbf)
- (b) Remove the 2 bolts, EGR pipe and gasket.
Torque: 27 N·m (270 kgf·cm, 20 ft·lbf)

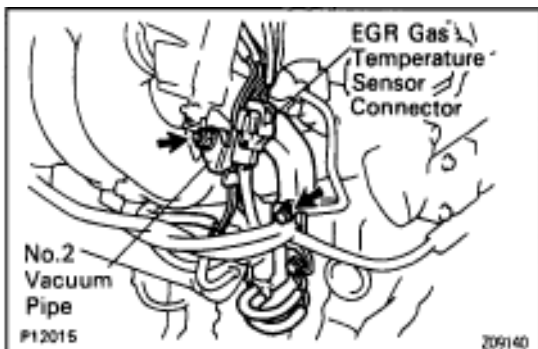

5. DISCONNECT EGR GAS TEMPERATURE SENSOR CONNECTOR

- (a) Disconnect the connector from the No.2 vacuum pipe.
- (b) Disconnect the sensor connector from the wiring connector.

6. DISCONNECT NO.2 VACUUM PIPE FROM AIR INTAKE CHAMBER AND INTAKE MANIFOLD

Remove the 2 nuts, and disconnect the vacuum pipe from the air intake chamber and intake manifold.

Torque: 27 N·m (270 kgf·cm, 20 ft·lbf)

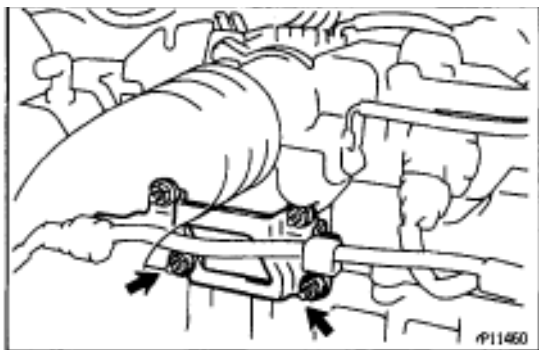

7. REMOVE AIR INTAKE CHAMBER (WITH INTAKE AIR CONTROL VALVE)

- (a) Remove the 2 nuts holding the throttle body bracket to the cylinder head.

Torque: 21 N·m (210 kgf·cm, 15 ft·lbf)

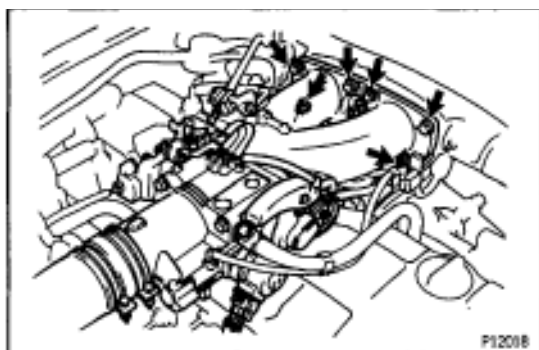

- (b) Remove the 4 bolts and 2 nuts holding the intake air connector to the air intake chamber.

Torque: 27 N·m (270 kgf·cm, 20 ft·lbf)

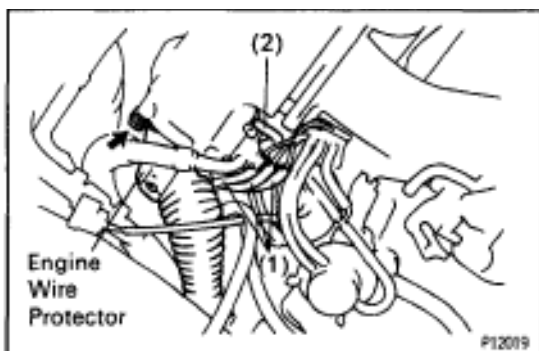

- (c) Remove the bolt, and disconnect the engine wire protector from the air intake chamber.

- (d) Disconnect these hoses:

- (1) 3 vacuum hoses (from No.2 vacuum pipe) from No.1 vacuum pipe
- (2) Vacuum hose (from No.2 vacuum pipe) from air intake chamber

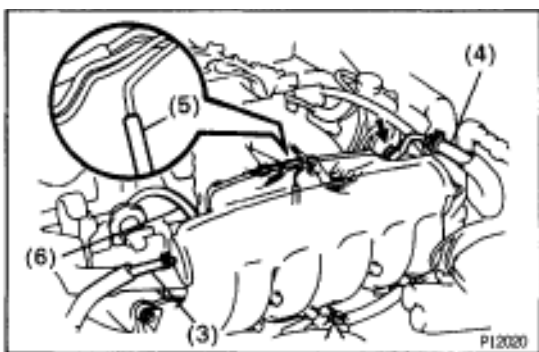

- (3) PS air hose from air intake chamber

- (4) Brake booster vacuum hose from air intake chamber
Remove the union bolt and 2 gaskets, and disconnect the vacuum hose.

Torque: 29 N·m (300 kgf·cm, 22 ft·lbf)

- (5) Vacuum hose (from actuator for ACIS) from No.1 vacuum pipe

- (6) Except California:
Vacuum sensing hose (from fuel pressure regulator) from air intake chamber

- (e) Loosen the 2 nuts holding the air intake chamber stays to the cylinder head.

Torque: 18 N·m (185 kgf·cm, 13 ft·lbf)

- (f) Remove the 2 bolts, and disconnect the 2 air intake chamber stays from the air intake chamber.

Torque: 18 N·m (185 kgf·cm, 13 ft·lbf)



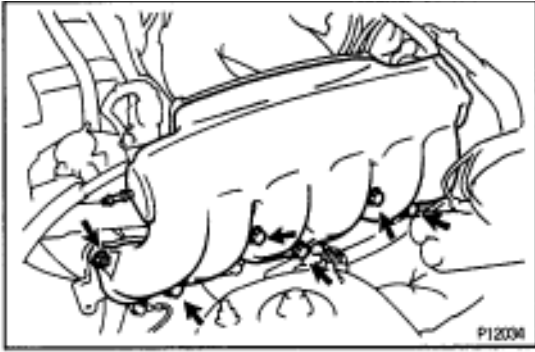

- (g) Remove the 5 bolts, nut, air intake chamber and 2 gaskets.
Torque: 27 N·m (270 kgf·cm, 20 ft·lbf)

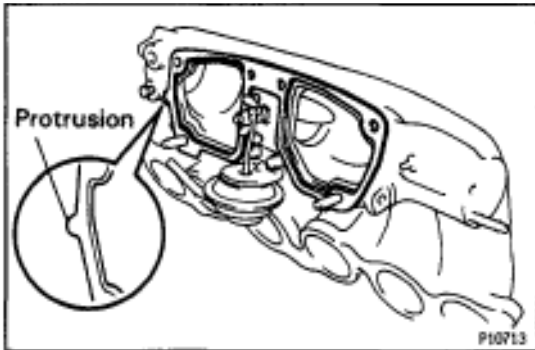

INSTALLATION HINT: Install a new gasket to the air intake chamber, facing the protrusion rearward.

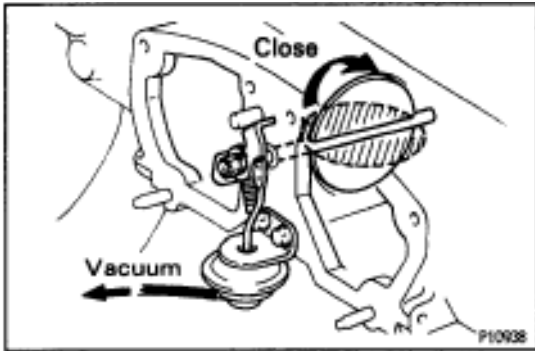

INTAKE AIR CONTROL VALVE INSPECTION

INSPECT INTAKE AIR CONTROL VALVE

- (a) With 53.3 kPa (400 mmHg, 15.75 in.Hg) of vacuum applied to the actuator, check that the actuator rod moves.

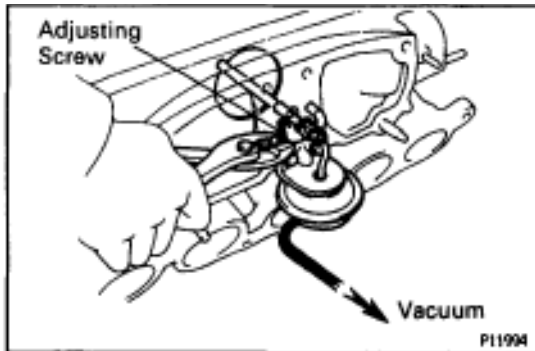

- If operation is not as specified, turn the adjusting screw.
(b) 1 minute after applying the vacuum in (a), check that the actuator rod does not return.

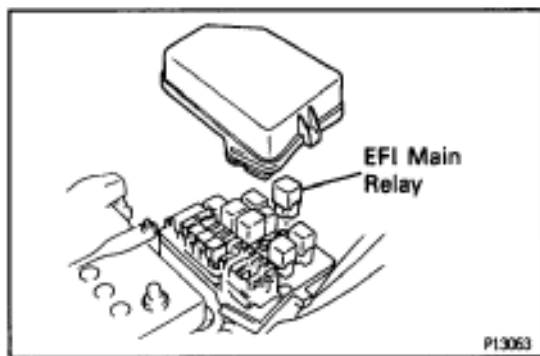

EFI MAIN RELAY

EFI MAIN RELAY INSPECTION

1. REMOVE EFI MAIN RELAY

LOCATION: In the engine compartment relay box.

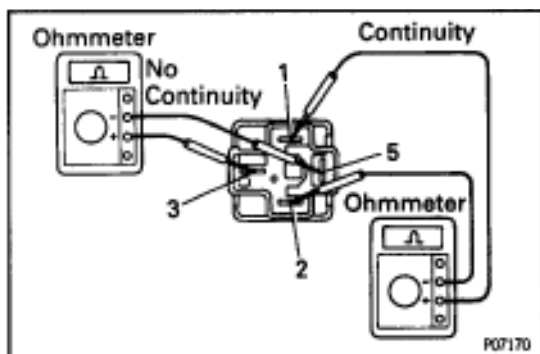

2. INSPECT EFI MAIN RELAY

A. Inspect relay continuity

- (a) Using an ohmmeter, check that there is continuity between terminals 1 and 2.
- (b) Check that there is no continuity between terminals 3 and 5. If continuity is not as specified, replace the relay.

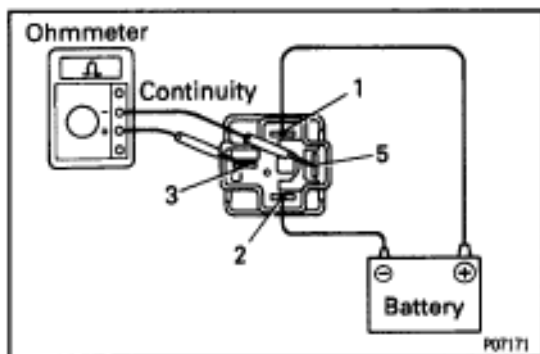

B. Inspect relay operation

- (a) Apply battery voltage across terminals 1 and 2.
- (b) Using an ohmmeter, check that there is continuity between terminals 3 and 5. If operation is not as specified, replace the relay.

3. REINSTALL EFI MAIN RELAY

VSV FOR ACIS COMPONENTS FOR REMOVAL AND INSTALLATION

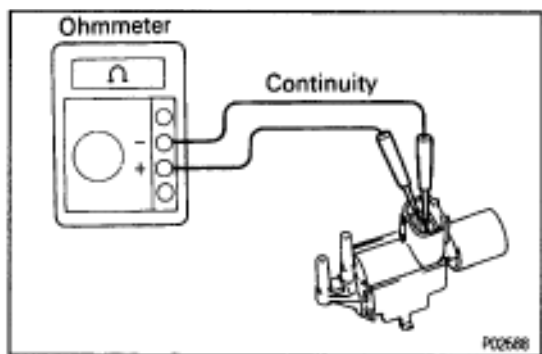
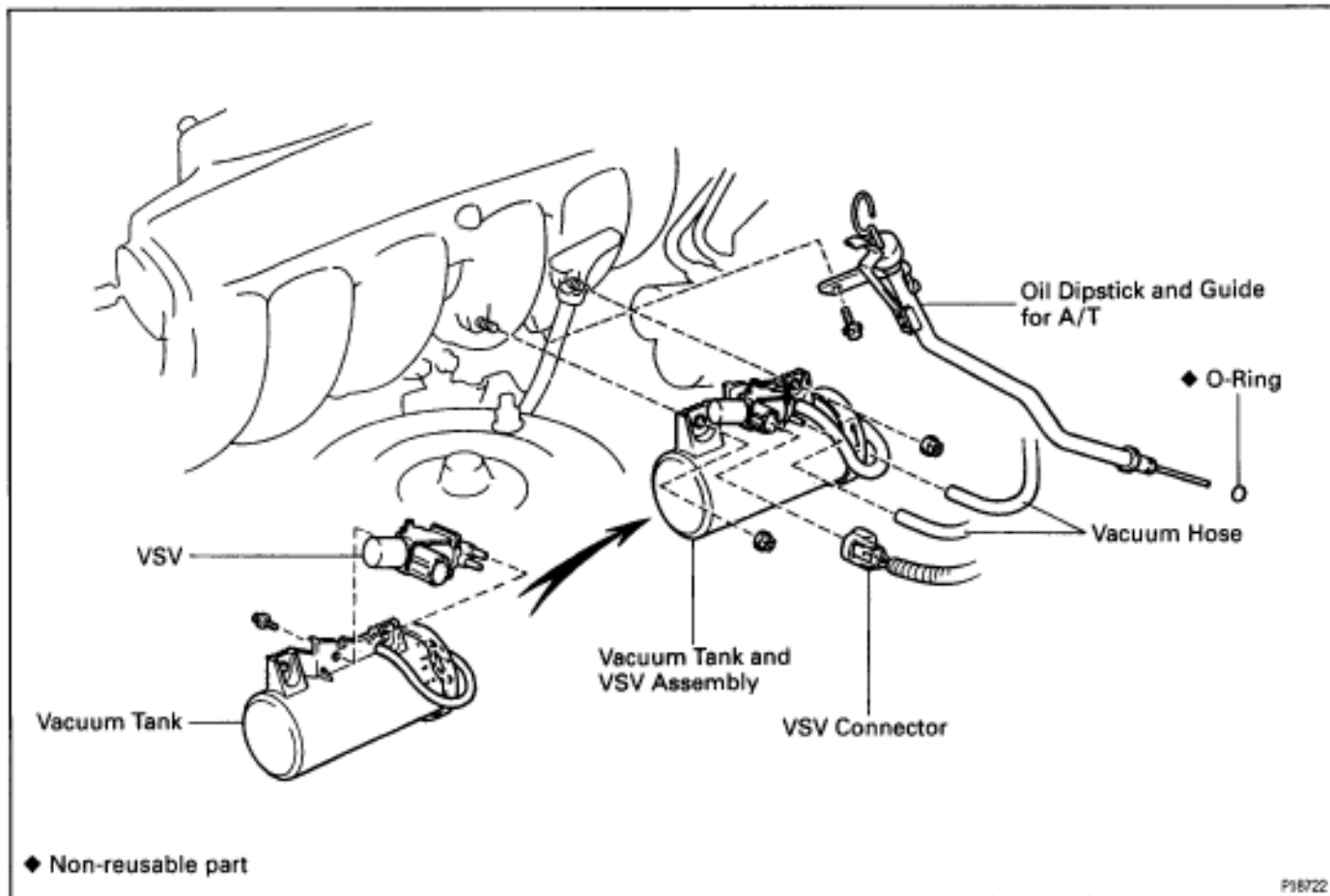

VSV INSPECTION

1. REMOVE VSV
2. INSPECT VSV
 - A. Inspect VSV for open circuit

Using an ohmmeter, check that there is continuity between the terminals.

Resistance:

At 20°C (68°F) 38.5–44.5 Ω

If there is no continuity, replace the VSV.

- B. Inspect VSV for ground

Using an ohmmeter, check that there is no continuity between each terminal and the body.

If there is continuity, replace the VSV.

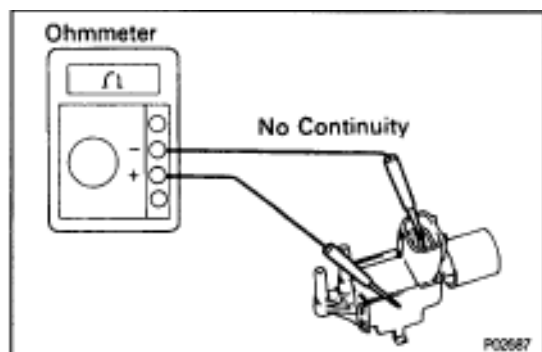

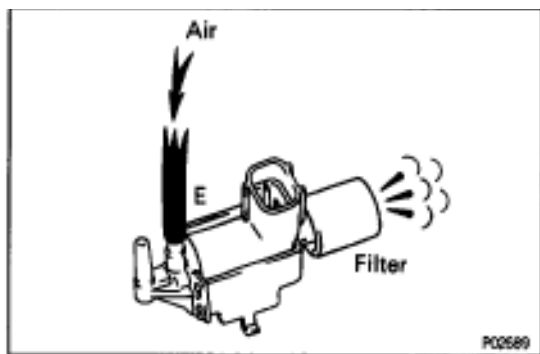

C. Inspect VSV operation

- (a) Check that air flows from port E to the filter.

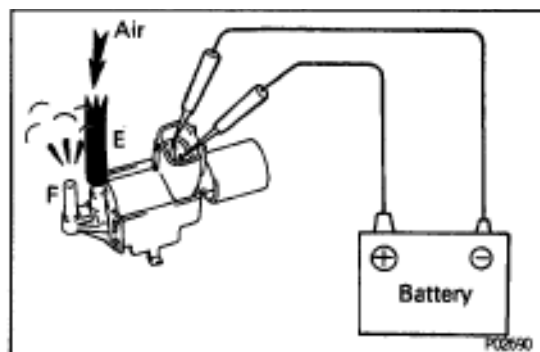

- (b) Apply battery voltage across the terminals.

- (c) Check that air flows from port E to F.
If operation is not as specified, replace the VSV.

3. REINSTALL VSV

VSV FOR FUEL PRESSURE CONTROL (California only) COMPONENTS FOR REMOVAL AND INSTALLATION

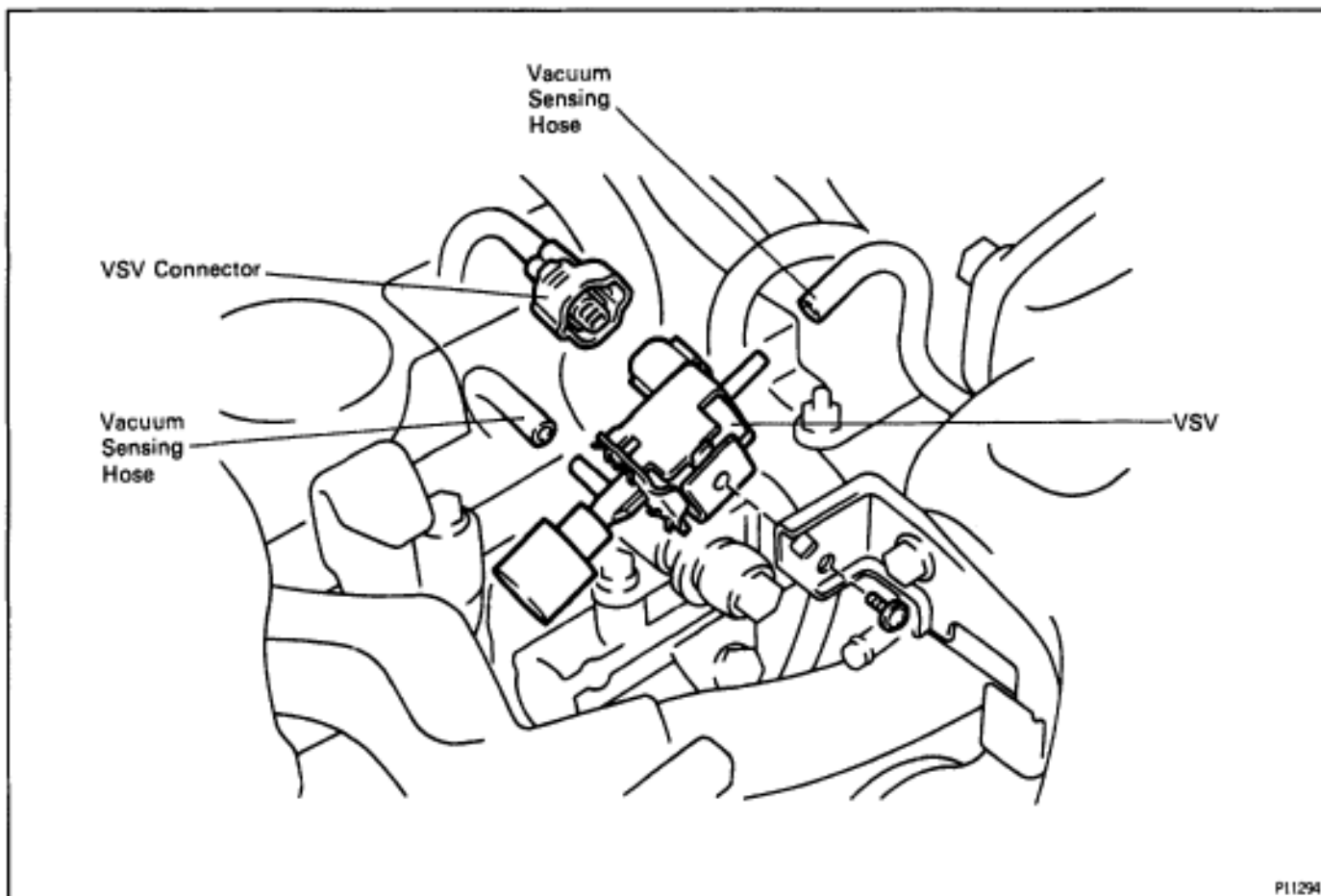

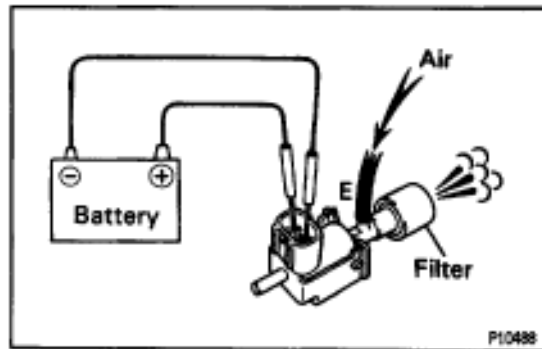
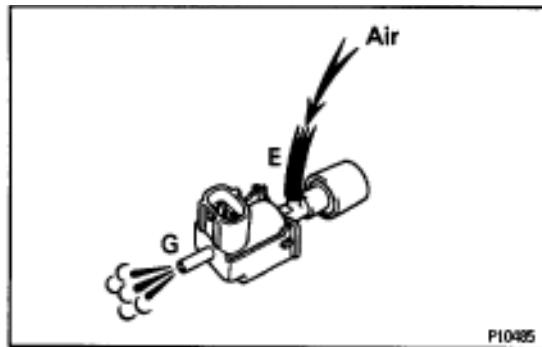
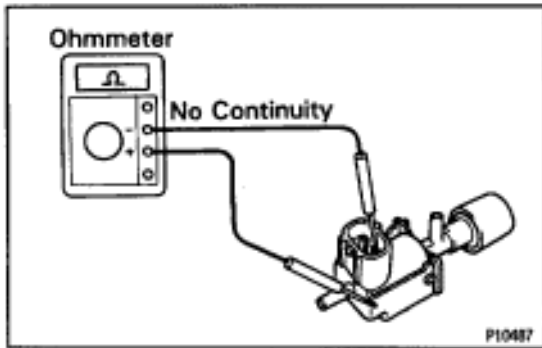
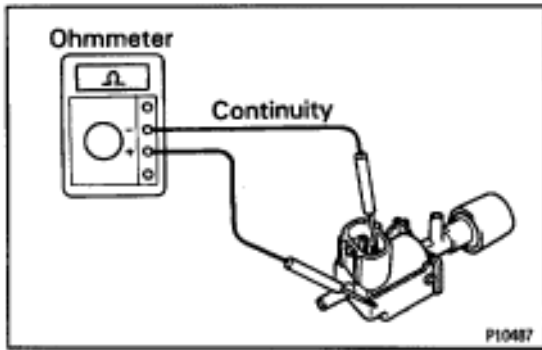

VSV INSPECTION

1. REMOVE VSV

2. INSPECT VSV

A. Inspect VSV for open circuit

Using an ohmmeter, check that there is continuity between the terminals.

Resistance:

At 20°C (68°F) 33–39 Ω

If there is no continuity, replace the VSV.

B. Inspect VSV for ground

Using an ohmmeter, check that there is no continuity between each terminal and the body.

If there is continuity, replace the VSV.

C. Inspect VSV operation

(a) Check that air flows from port E to G.

(b) Apply battery voltage across the terminals.

(c) Check that air flows from port E to the filter.

If operation is not as specified, replace the VSV.

3. REINSTALL VSV

VSV FOR EVAP COMPONENTS FOR REMOVAL AND INSTALLATION

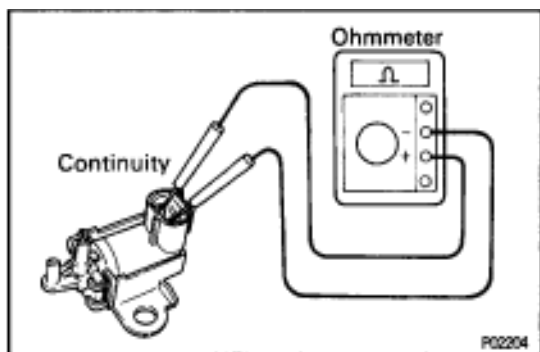
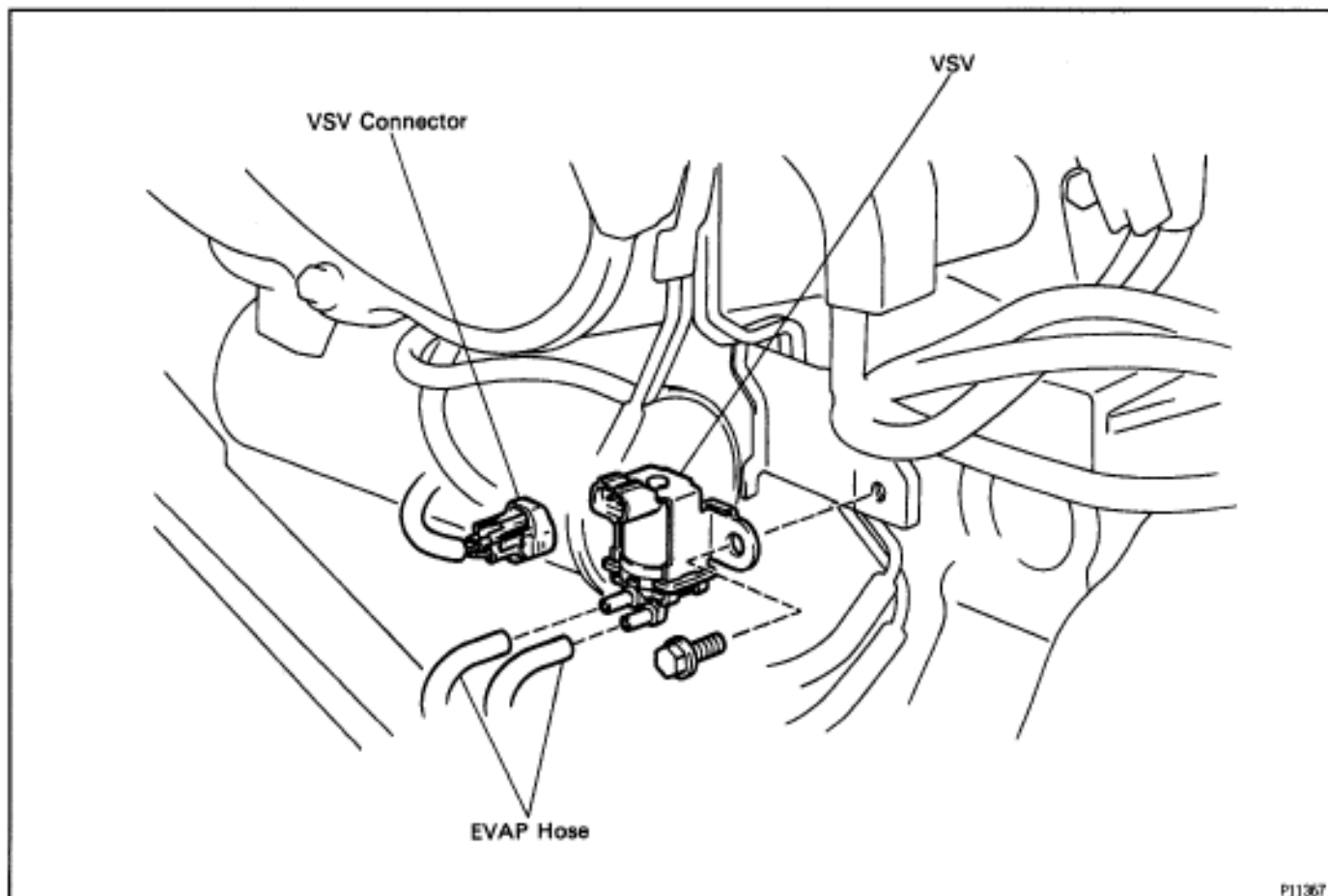

VSV INSPECTION

1. REMOVE VSV
2. INSPECT VSV
 - A. Inspect VSV for open circuit

Using an ohmmeter, check that there is continuity between the terminals.

Resistance:

At 20°C (68°F) 27–33 Ω

If there is no continuity, replace the VSV.

- B. Inspect VSV for ground

Using an ohmmeter, check that there is no continuity between each terminal and the body.

If there is continuity, replace the VSV.

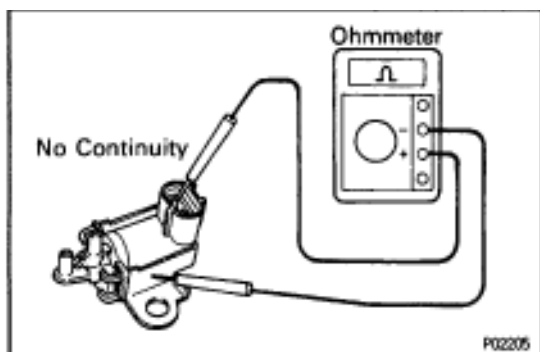

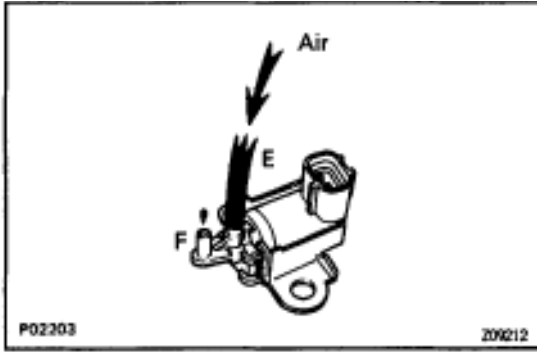

C. Inspect VSV operation

- (a) Check that air does not flow from port E to F.

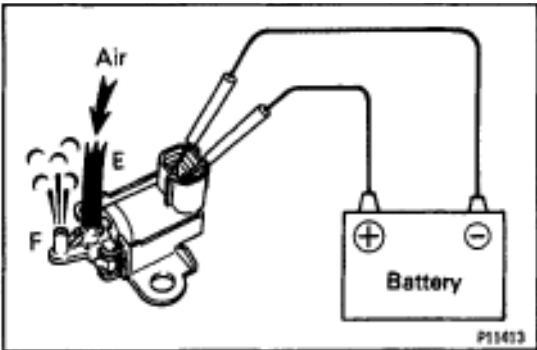

- (b) Apply battery voltage across the terminals.

- (c) Check that air flows from port E to F.

If operation is not as specified, replace the VSV.

3. REINSTALL VSV

VSV FOR EGR COMPONENTS FOR REMOVAL AND INSTALLATION

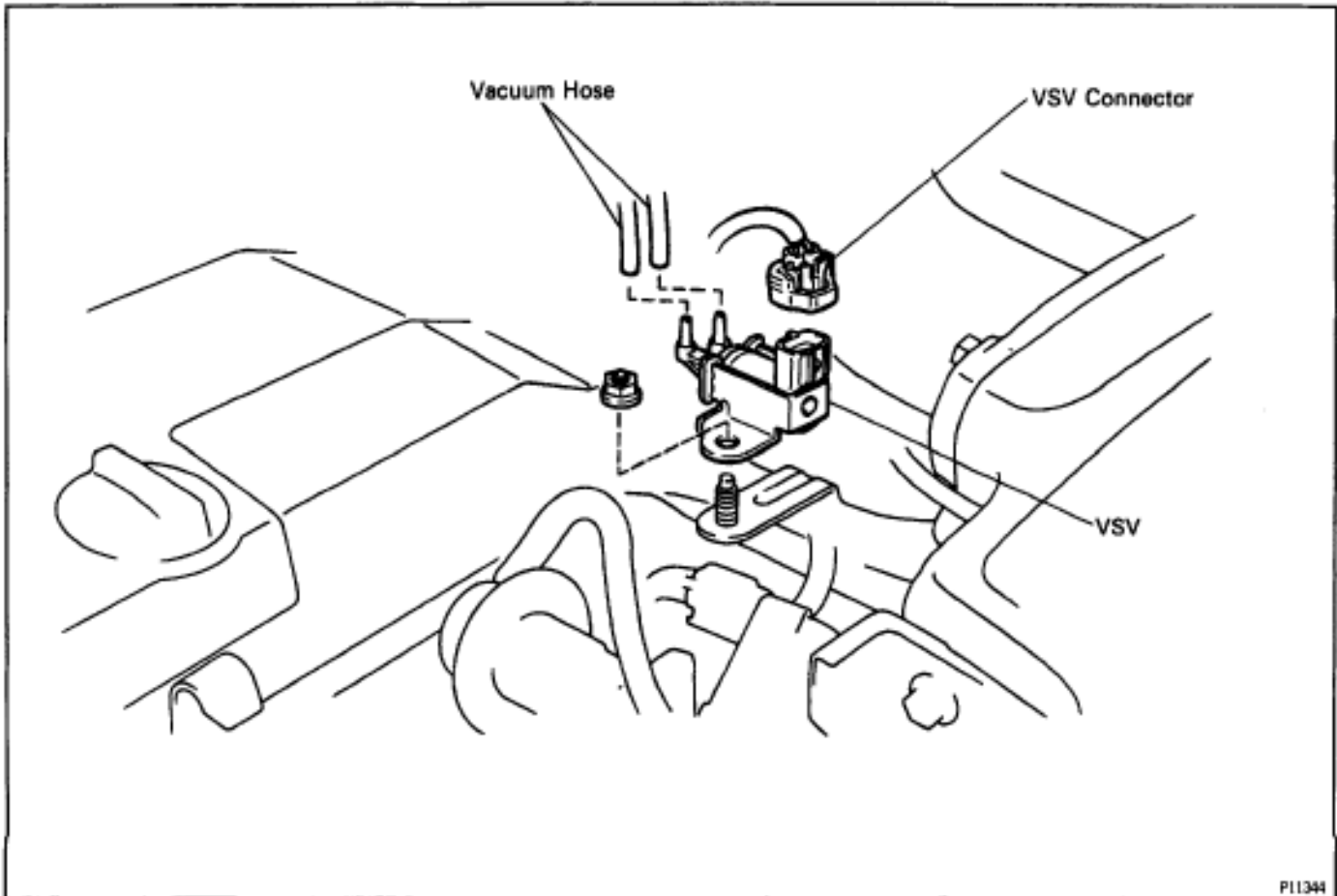

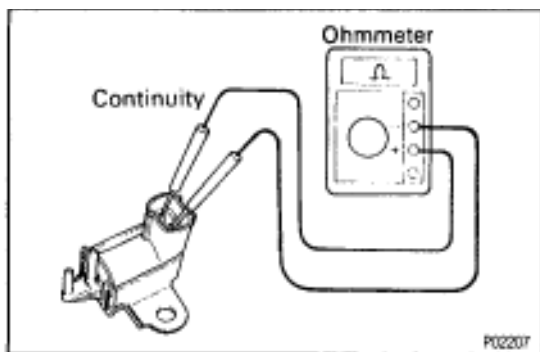

VSV INSPECTION

1. REMOVE VSV

2. INSPECT VSV

A. Inspect VSV for open circuit

Using an ohmmeter, check that there is continuity between the terminals.

Resistance:

At 20°C (68°F) 38.5–44.5 Ω

If there is no continuity, replace the VSV.

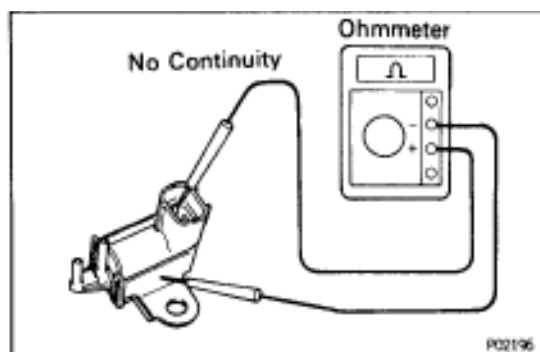

B. Inspect VSV for ground

Using an ohmmeter, check that there is no continuity between each terminal and the body.

If there is continuity, replace the VSV.

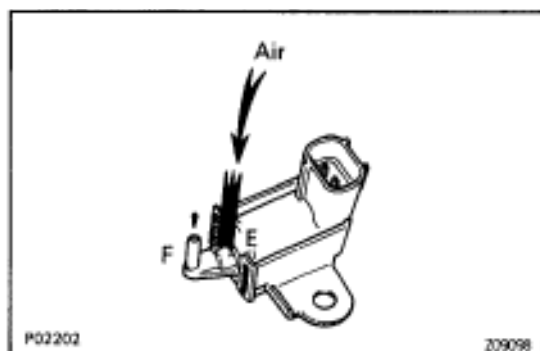

C. Inspect VSV operation

(a) Check that air does not flow from port E to F.

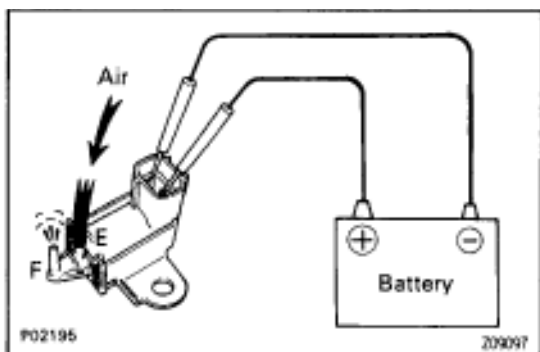

(b) Apply battery voltage across the terminals.

(c) Check that air flows from port E to F.

If operation is not as specified, replace the VSV.

3. REINSTALL VSV

ENGINE COOLANT TEMPERATURE (ECT) SENSOR COMPONENTS FOR REMOVAL AND INSTALLATION

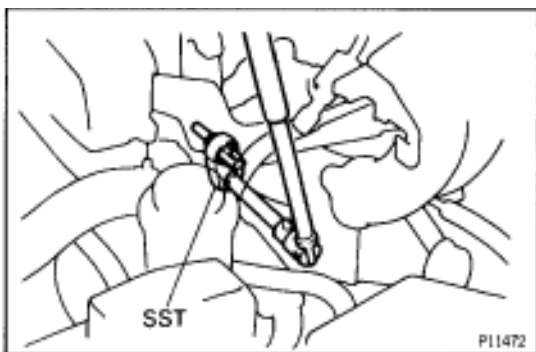
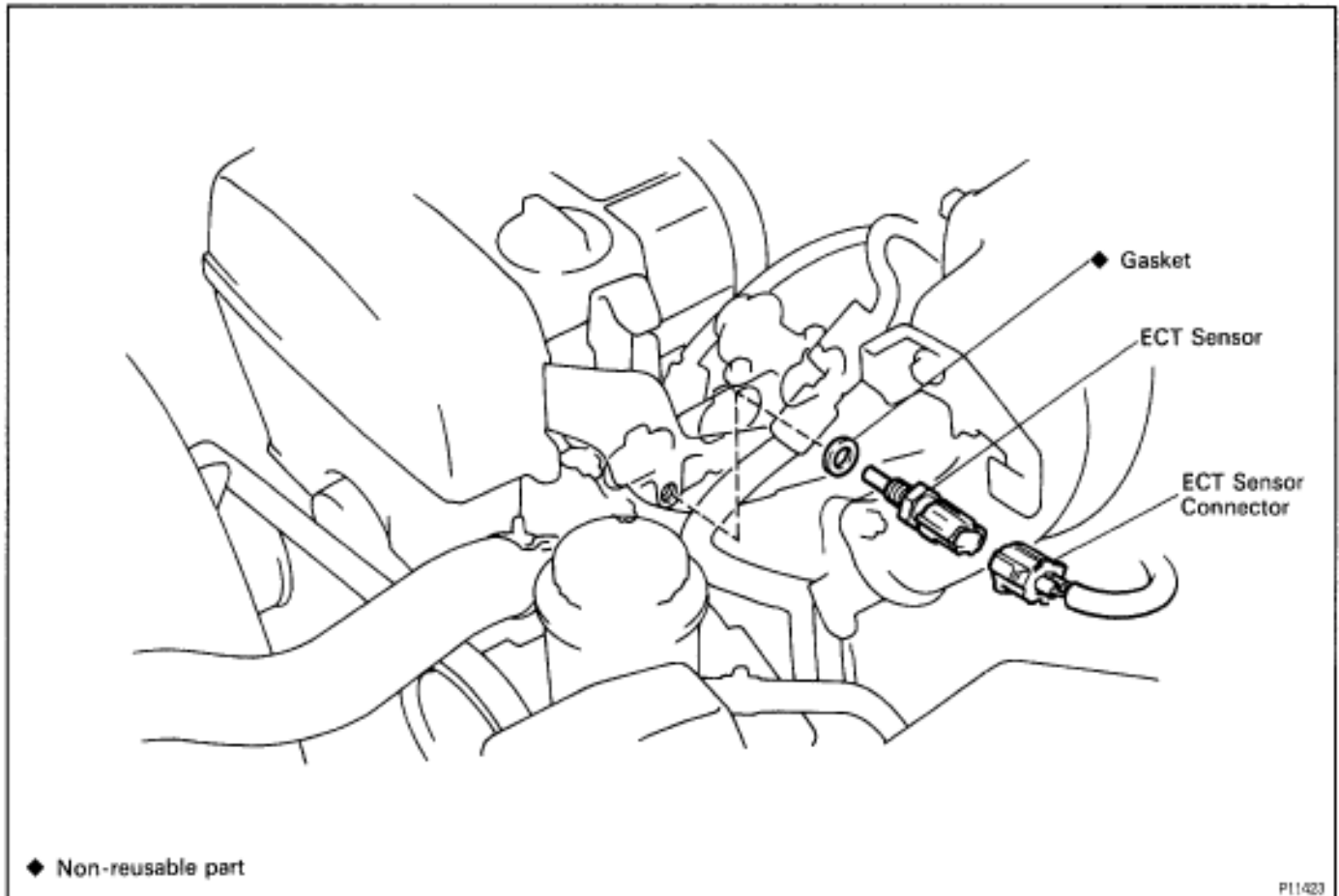

ECT SENSOR INSPECTION

1. DRAIN ENGINE COOLANT
2. REMOVE ECT SENSOR
 - (a) Disconnect the ECT sensor connector.
 - (b) Using SST, remove the ECT sensor and gasket.
SST 09205-76030

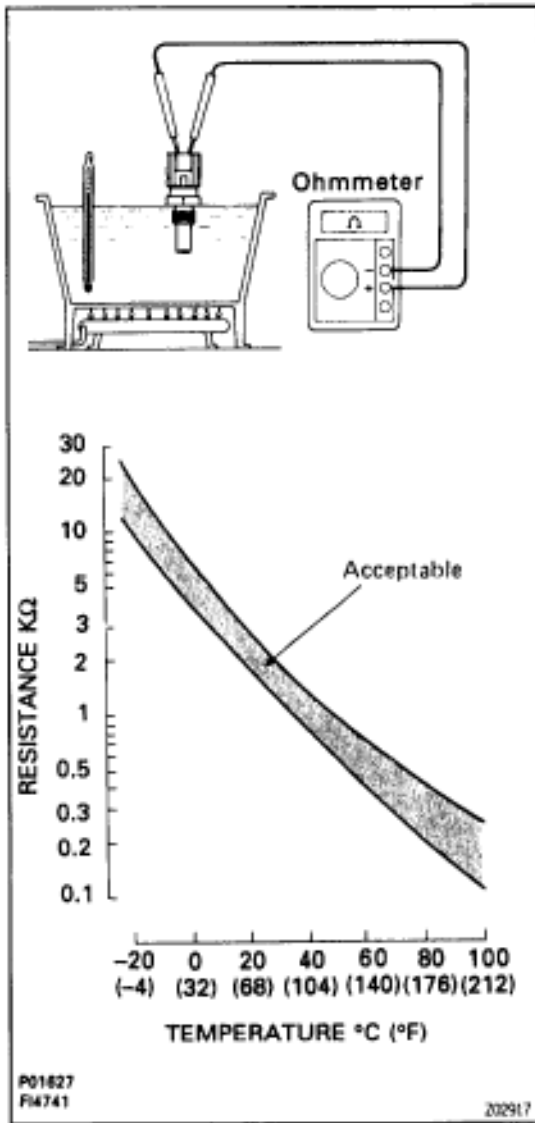

3. INSPECT ECT SENSOR

Using an ohmmeter, measure the resistance between the terminals.

Resistance:

Refer to the graph

If the resistance is not as specified, replace the ECT sensor.

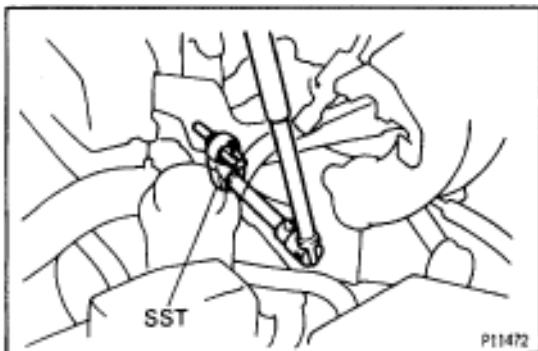

4. REINSTALL ECT SENSOR

- Install a new gasket to the ECT sensor.
- Using SST, install the ECT sensor.
SST 09205-76030
- Connect the ECT sensor connector.

5. REFILL WITH ENGINE COOLANT

EGR GAS TEMPERATURE SENSOR COMPONENTS FOR REMOVAL AND INSTALLATION

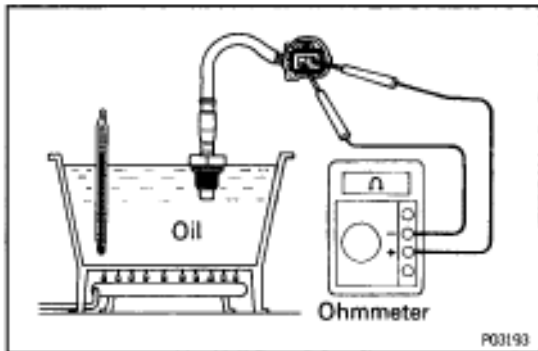
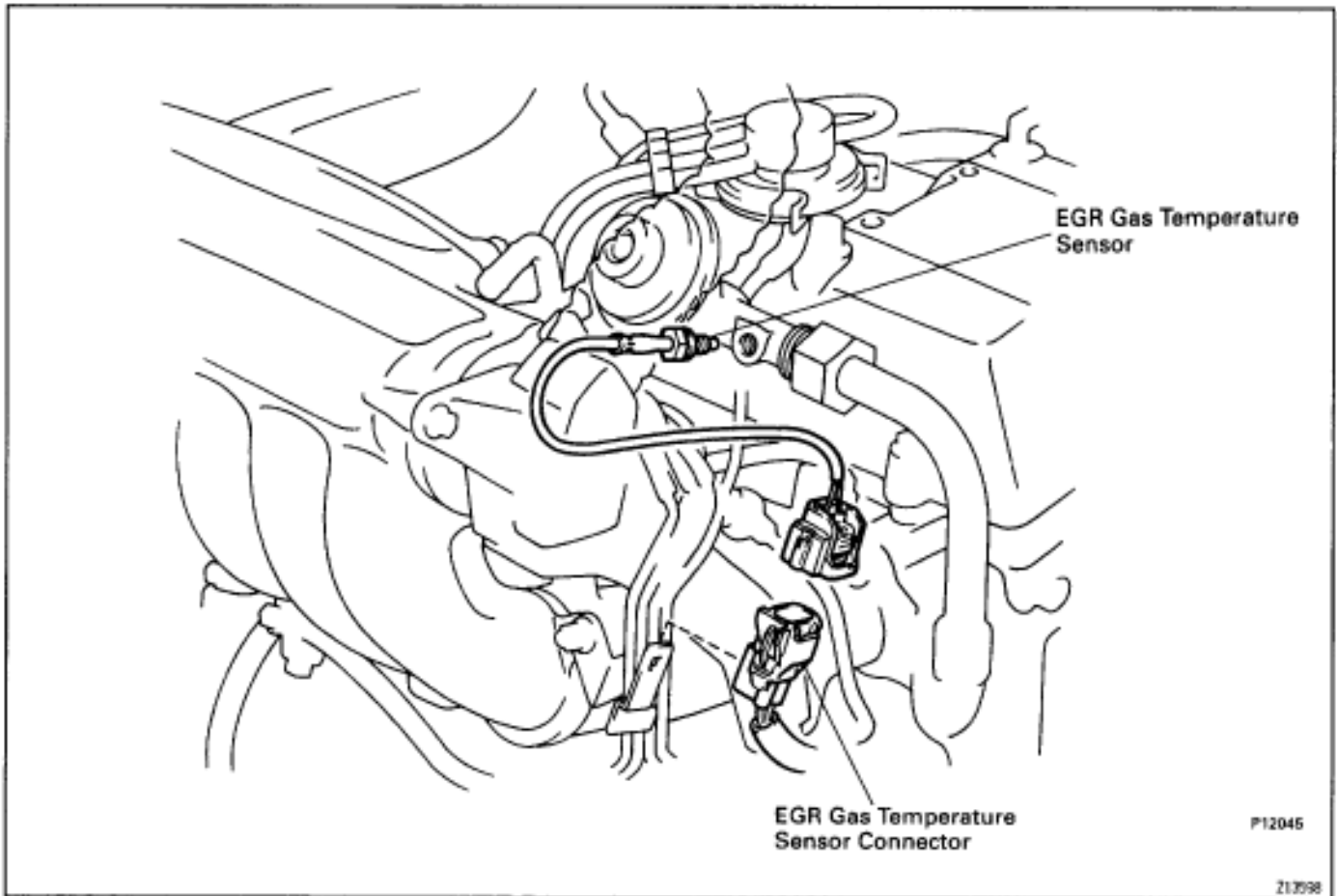

EGR GAS TEMPERATURE SENSOR INSPECTION

1. REMOVE EGR GAS TEMPERATURE SENSOR
2. INSPECT EGR GAS TEMPERATURE SENSOR
Using an ohmmeter, measure the resistance between the terminals.

Resistance:

At 50°C (112°F)

64–97 kΩ

At 100°C (212°F)

11–16 kΩ

At 150°C (302°F)

2–4 kΩ

If the resistance is not as specified, replace the sensor.

Torque: 20 N·m (200 kgf·cm, 14 ft·lbf)

3. REINSTALL EGR GAS TEMPERATURE SENSOR

KNOCK SENSOR COMPONENTS FOR REMOVAL AND INSTALLATION

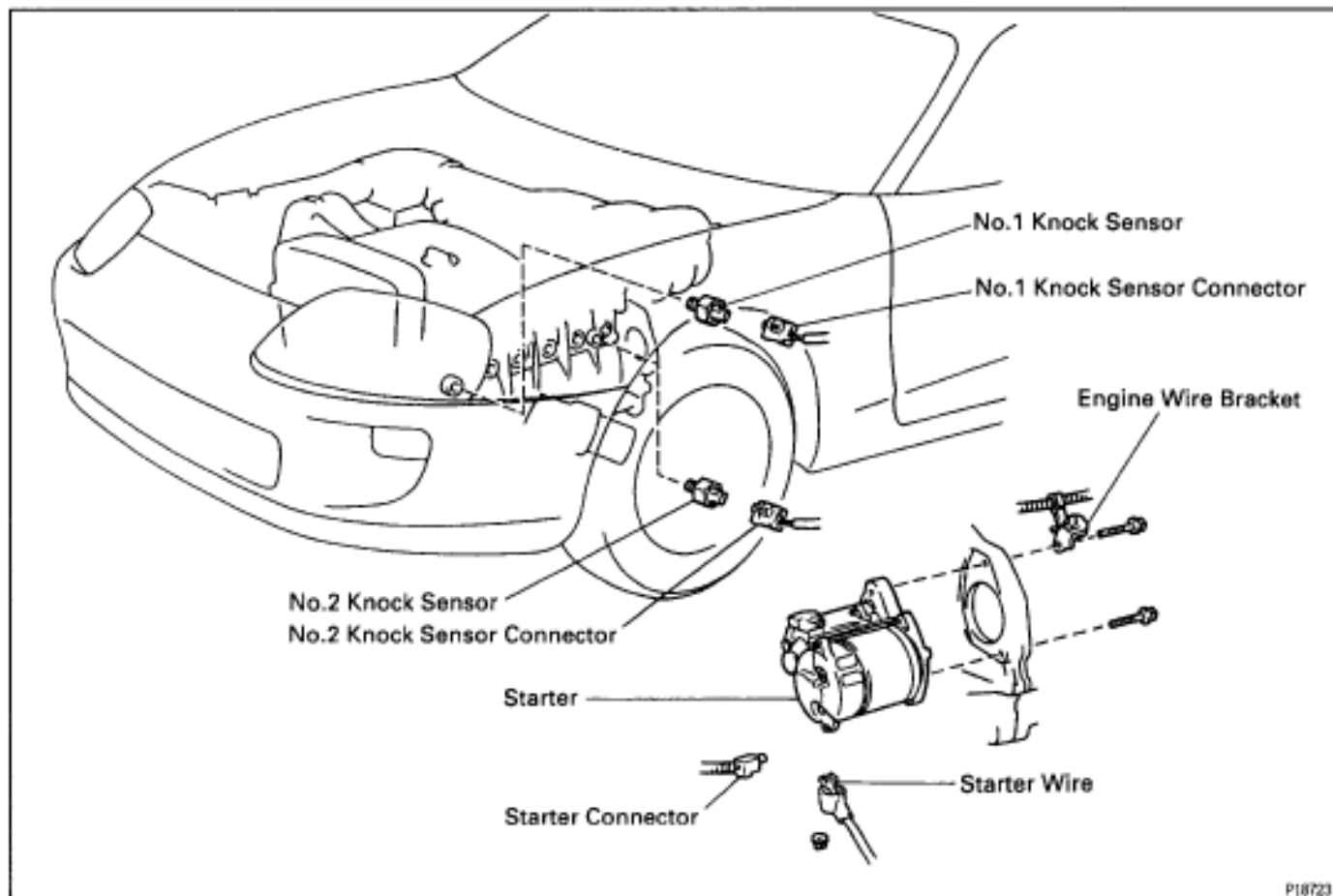

P18723

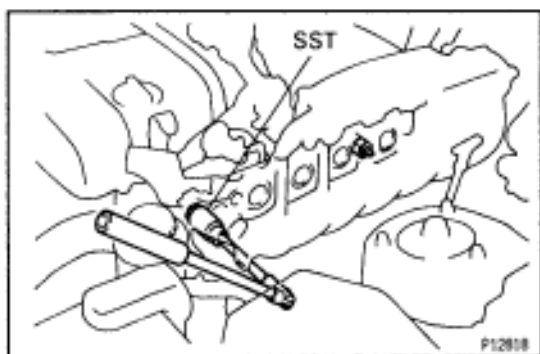

P12818

KNOCK SENSORS INSPECTION

1. REMOVE STARTER
(See starter removal in Starting System)
2. REMOVE KNOCK SENSORS
 - (a) Disconnect the knock sensor connector.
 - (b) Using SST, remove the knock sensor.
SST 09816-30010

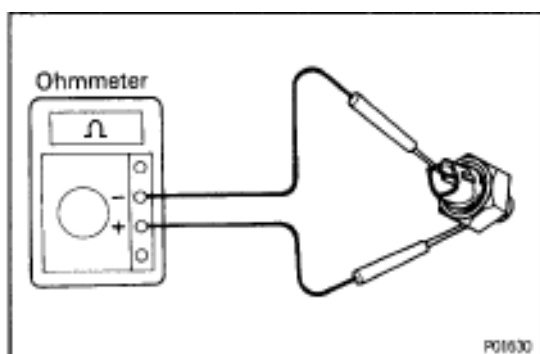

P01630

3. INSPECT KNOCK SENSORS

Using an ohmmeter, check that there is no continuity between the terminal and body.
If there is continuity, replace the sensor.

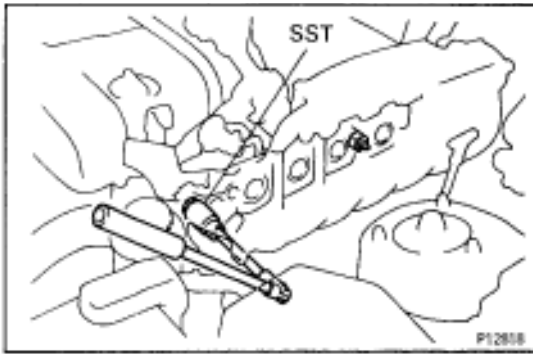

4. REINSTALL KNOCK SENSORS

(a) Using SST, install the knock sensor.

SST 09816-30010

Torque: 44 N·m (450 kgf·cm, 33 ft·lbf)

(b) Connect the knock sensor connector.

5. REINSTALL STARTER

(See starter installation in Starting System)

OXYGEN SENSOR

Main Heated Oxygen Sensors
(California) or Oxygen Sensors (Except
California)

COMPONENTS FOR REMOVAL AND INSTALLATION

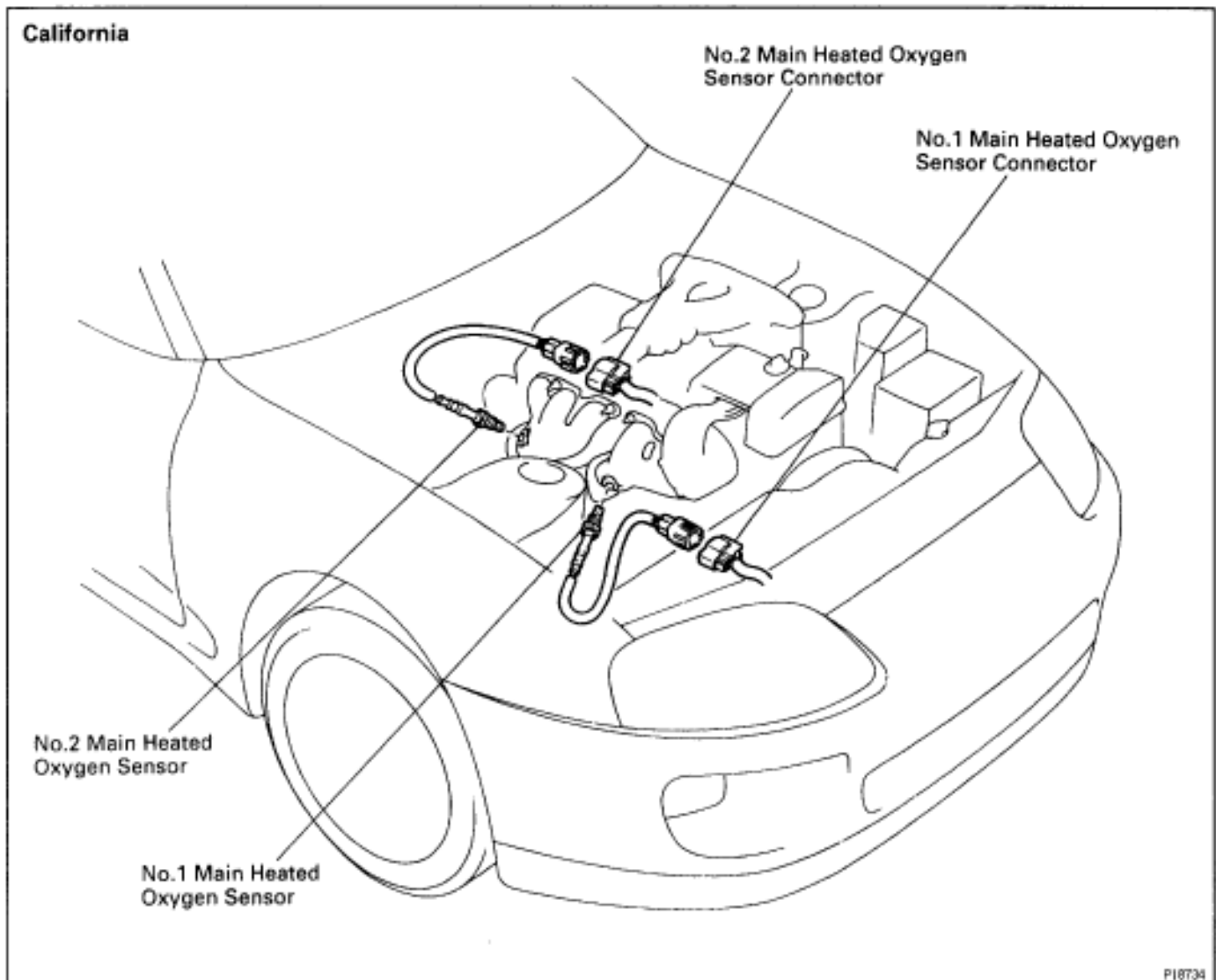

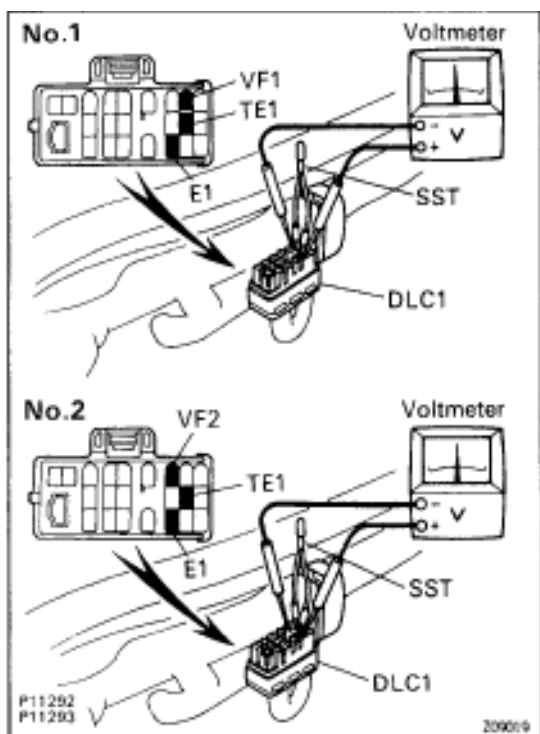
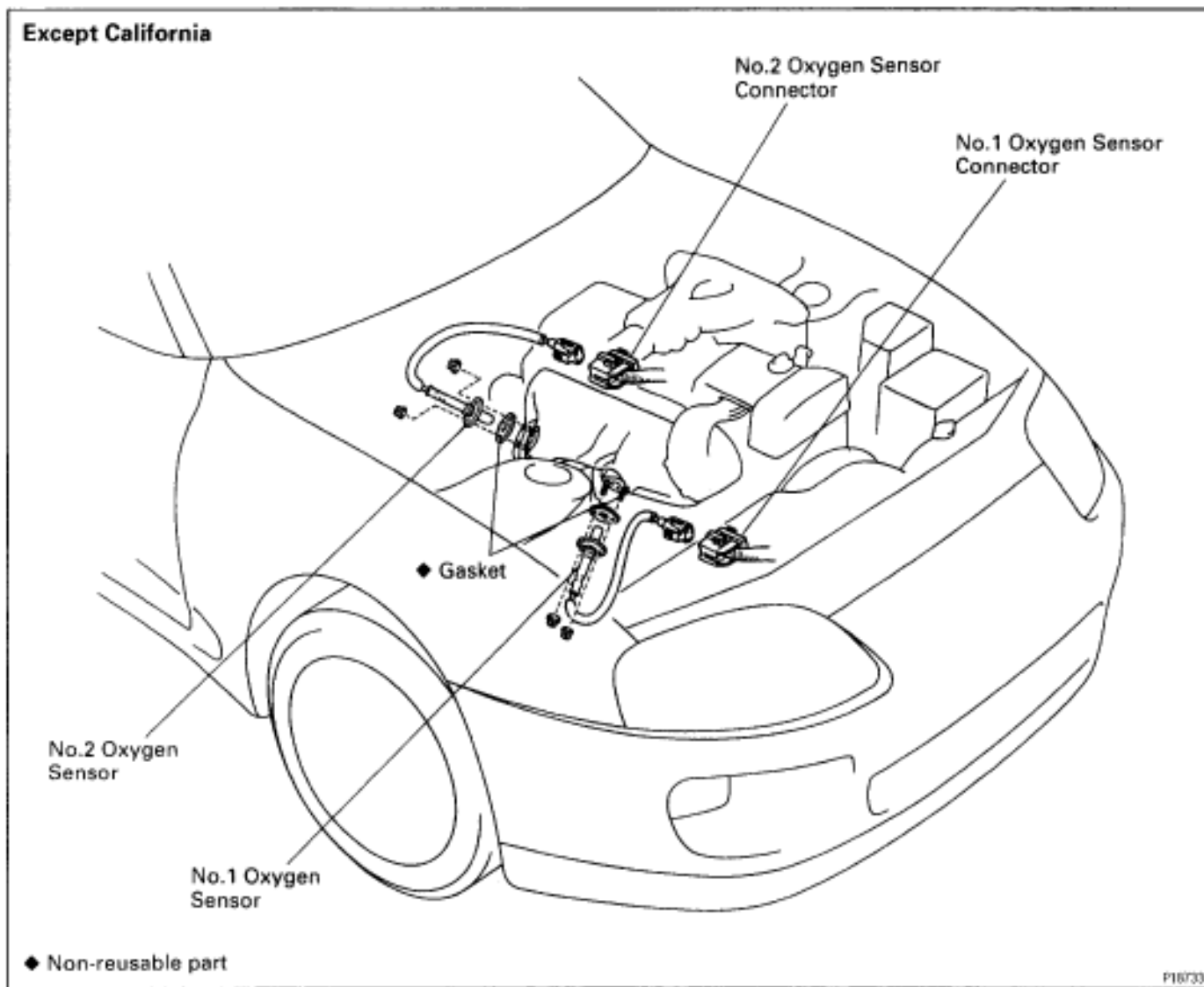

OXYGEN SENSORS INSPECTION

1. WARM UP ENGINE

Allow the engine to warm up to normal operating temperature.

2. INSPECT FEEDBACK VOLTAGE

Connect the positive (+) tester probe of a voltmeter to terminal VF1 (for No.1) or VF2 (for No.2) of the DLC 1, and negative (-) tester probe to terminal E1. Do the test as described on the next page.

HINT: Use SST when connecting between terminals TE1 and E1 of the DLC1.

SST 09843-18020

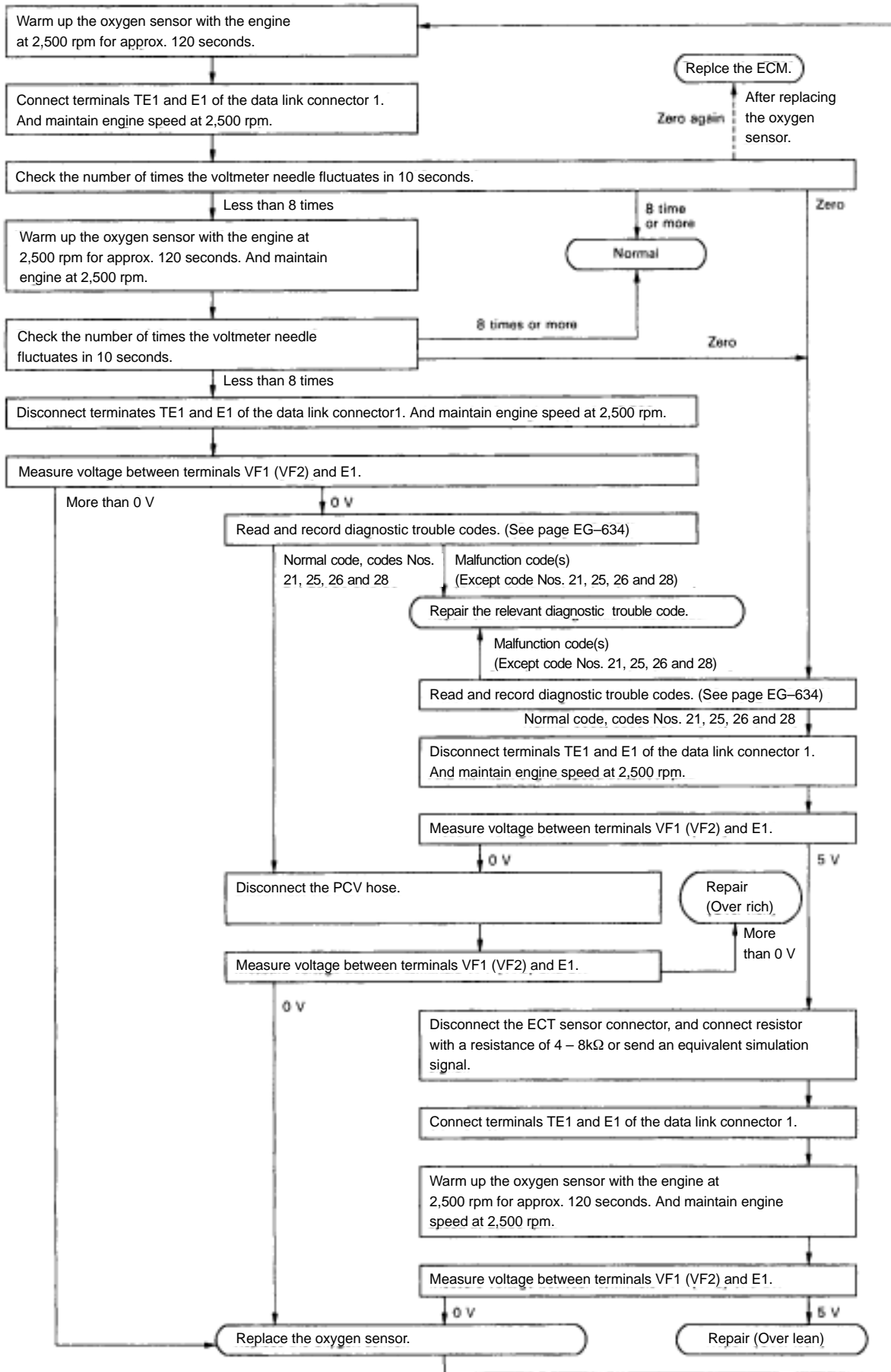

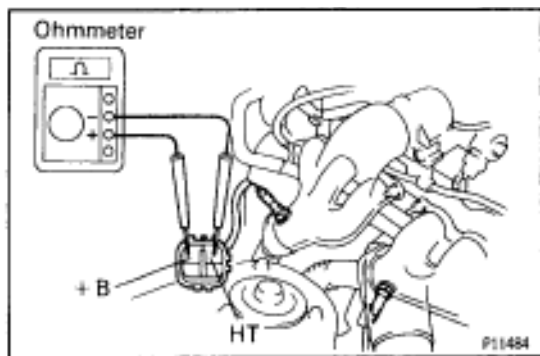

3. **California only:**
INSPECT HEATER RESISTANCE OF MAIN HEATED OXYGEN SENSORS

- (a) Disconnect the oxygen sensor connectors.
- (b) Using an ohmmeter, measure the resistance between the terminals +B and HT.

Resistance:

At 20°C (68°F) 11–16 Ω

If the resistance is not as specified, replace the sensor.

Torque: 44 N·m (450 kgf·cm, 33 ft·lbf)

- (c) Reconnect the oxygen sensor connectors.

Sub Heated Oxygen Sensor (California only) COMPONENTS FOR REMOVAL AND INSTALLATION

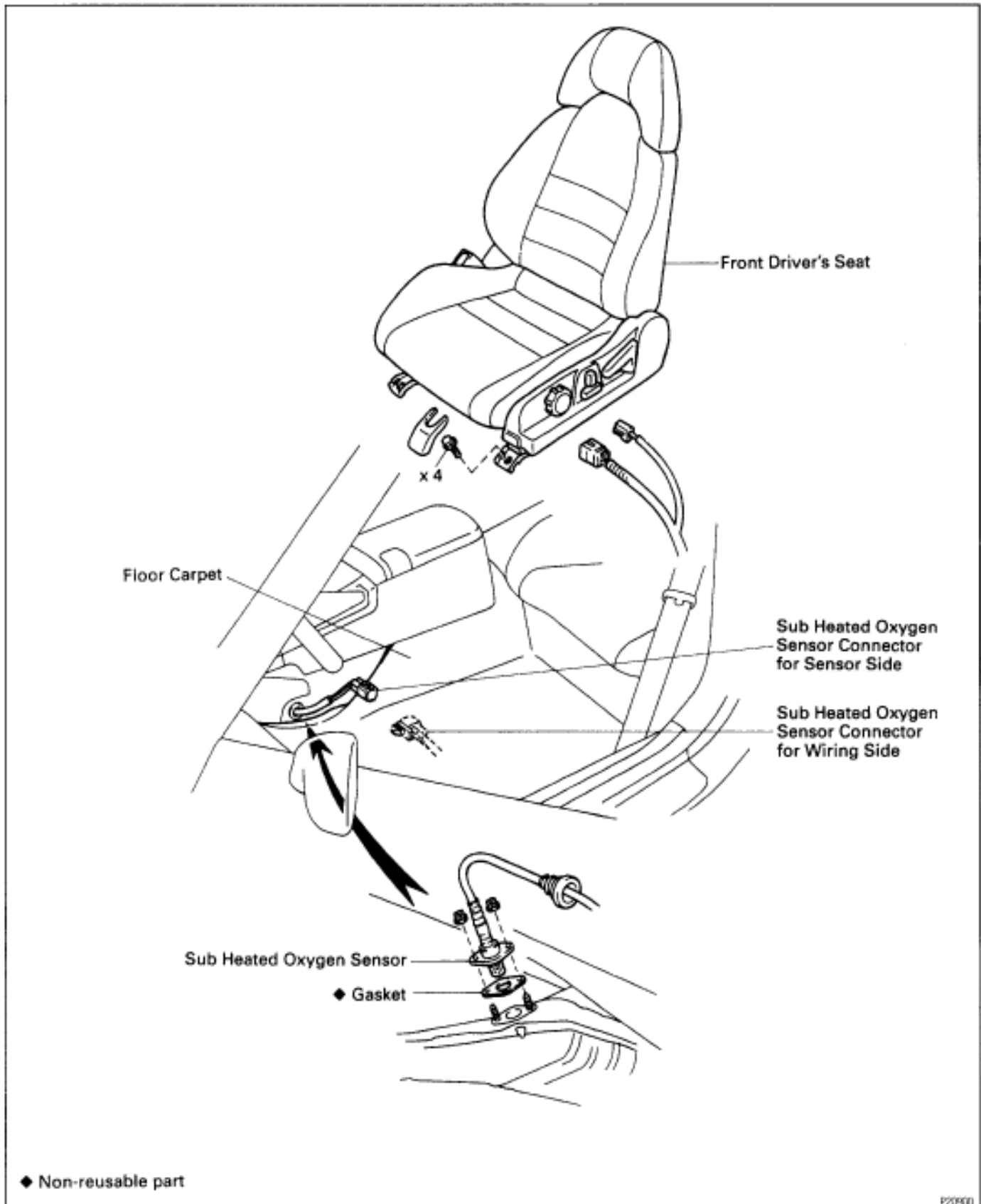

OXYGEN SENSOR INSPECTION

1. INSPECT OPERATION OF SUB HEATED OXYGEN SENSOR

(See circuit inspection in Engine Troubleshooting)

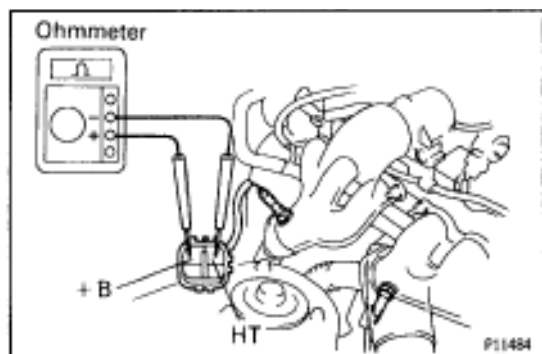

2. INSPECT HEATER RESISTANCE OF SUB HEATED OXYGEN SENSOR

- Remove the driver's seat.
- Take out the console box side of the floor carpet.
- Disconnect the oxygen sensor connector.
- Using an ohmmeter, measure the resistance between the terminals +B and HT.

Resistance:

At 20°C (68°F) 11–16 Ω

If the resistance is not as specified, replace the sensor.

Torque: 20 N·m (200 kgf·cm, 14 ft·lbf)

- Reconnect the oxygen sensor connector.
- Reinstall the floor carpet.
- Reinstall the driver's seat.

FUEL PUMP ECU COMPONENTS FOR REMOVAL AND INSTALLATION

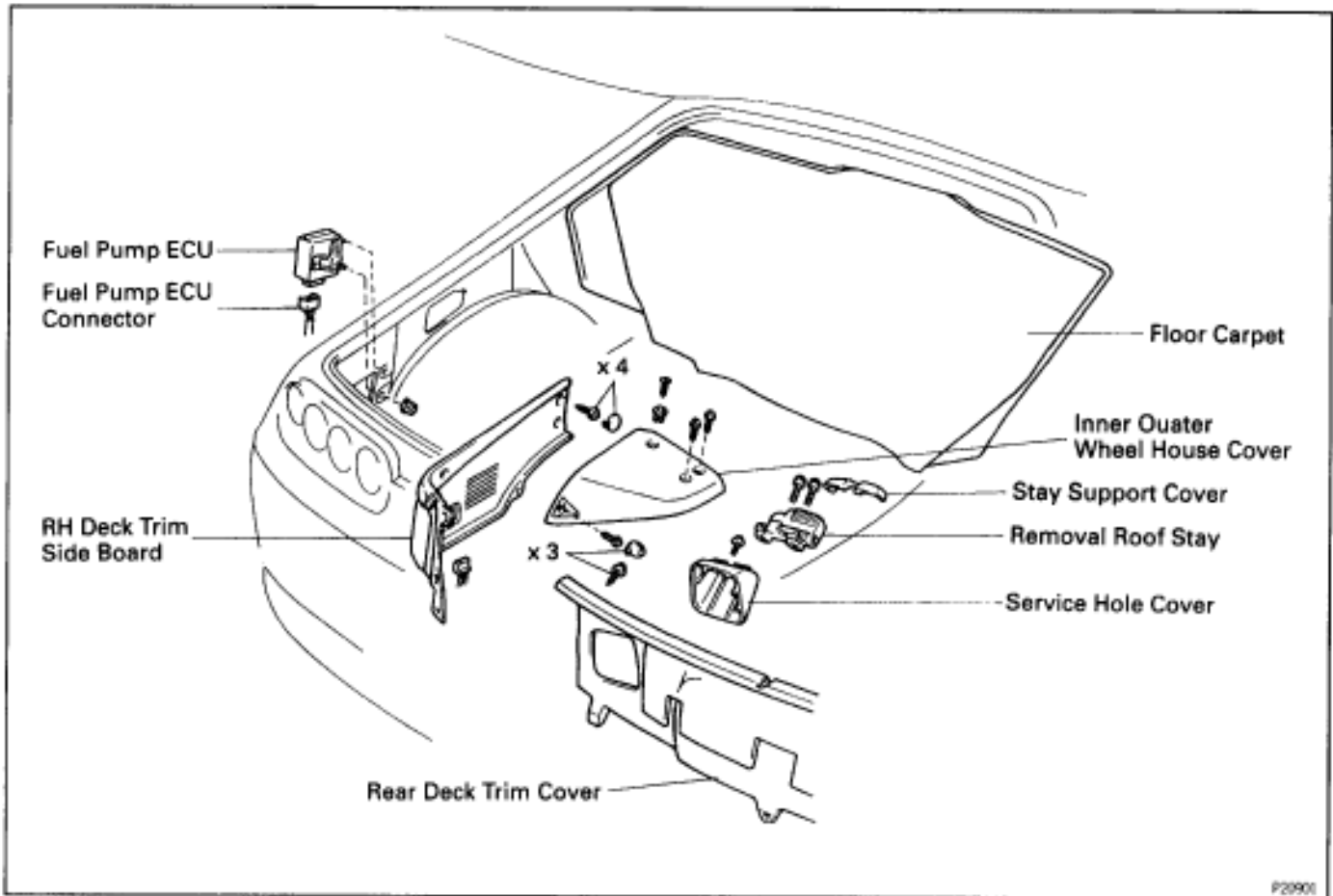

FUEL PUMP ECU INSPECTION

1. REMOVE FUEL PUMP ECU
2. INSPECT FUEL PUMP ECU
(See circuit inspection in Engine Troubleshooting)
3. REINSTALL FUEL PUMP ECU

ENGINE CONTROL MODULE (ECM) COMPONENTS FOR REMOVAL AND INSTALLATION

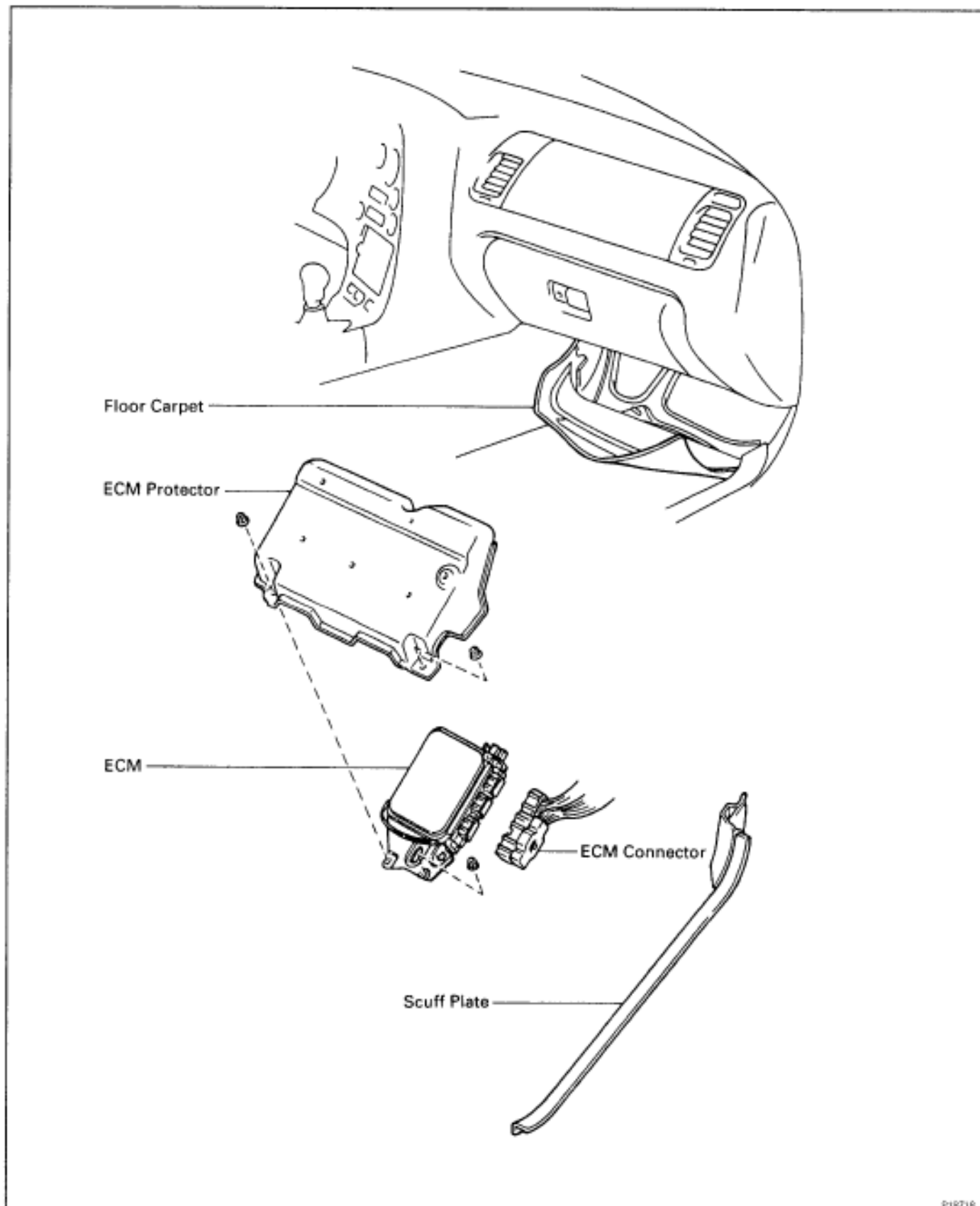

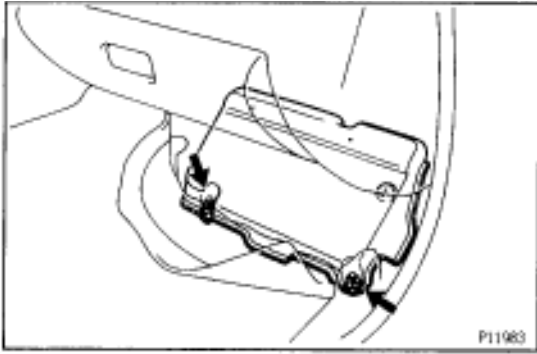

ECM INSPECTION

1. **DISCONNECT NEGATIVE (-) TERMINAL CABLE FROM BATTERY**
2. **REMOVE SCUFF PLATE**
3. **REMOVE ECM PROTECTOR**
 - (a) Take out the front side of the floor carpet.
 - (b) Remove the 2 nuts and ECM protector.

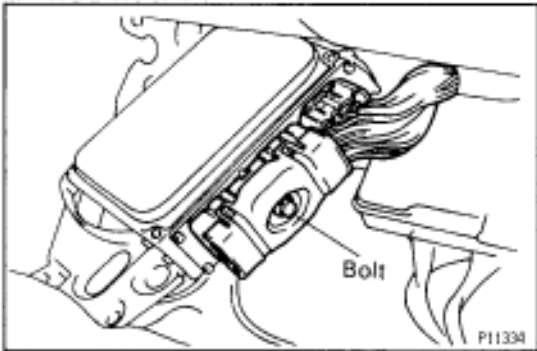

4. **REMOVE ECM**
 - (a) Remove the nut, and disconnect the ECM from the floor panel.
 - (b) Fully loosen the bolt and disconnect the 2 ECM connectors, and remove the ECM.
5. **INSPECT ECM**
(See standard value of ECM terminals in Engine Troubleshooting)

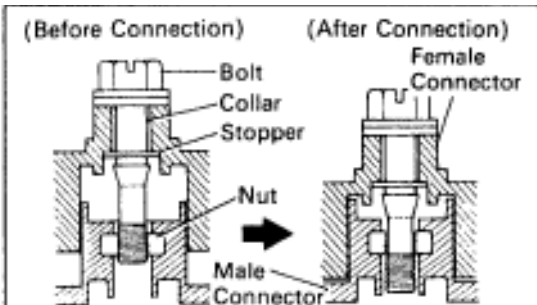

6. **REINSTALL ECM**
 - (a) Connect the 2 ECM connectors.
 - Match the male connector correctly with the female connector, then press them together.
 - Tighten the bolt.

Make sure the connector is completely connected by tightening the bolt until there is a clearance of less than 1 mm (0.04 in.) between the bottom of the male connector and the end of the female connector.

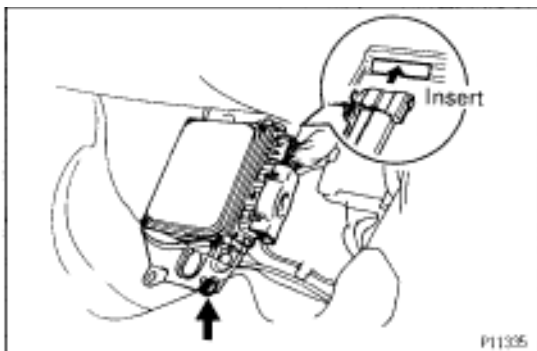
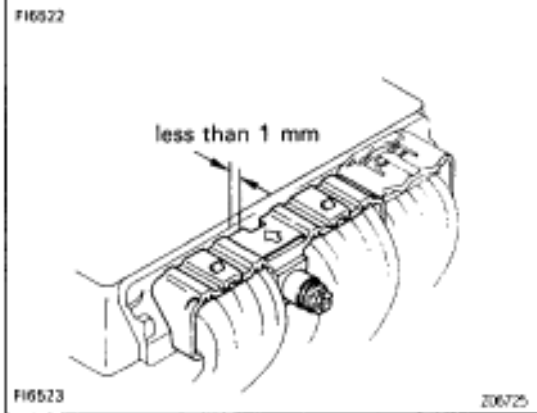

- (b) Insert the ECM bracket into the stay on the floor panel.
- (c) Install the ECM with the nut.
7. **REINSTALL ECM PROTECTOR**
8. **REINSTALL SCUFF PLATE**
9. **RECONNECT NEGATIVE (-) TERMINAL CABLE TO BATTERY**

FUEL CUT RPM FUEL CUT RPM INSPECTION

1. WARM UP ENGINE

Allow the engine to warm up to normal operating temperature.

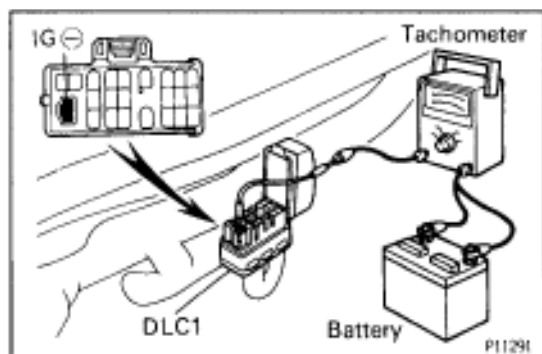

2. CONNECT TACHOMETER TO ENGINE

Connect the tester probe of a tachometer to terminal IG \ominus of the DLC1.

NOTICE:

- Never allow the tachometer terminal to touch ground as it could result in damage to the igniter and/or ignition coil.
- As some tachometers are not compatible with this ignition system, we recommend that you confirm the compatibility of your unit before use.

3. INSPECT FUEL CUTOFF OPERATION

- Increase the engine speed to at least 3,000 rpm.
- Check for injector operating noise.
- Check that when the throttle lever is released, injector operation noise stops momentarily and then resumes.

HINT: Measure with the A/C OFF.

Fuel return speed:

1,400 rpm

4. DISCONNECT TACHOMETER

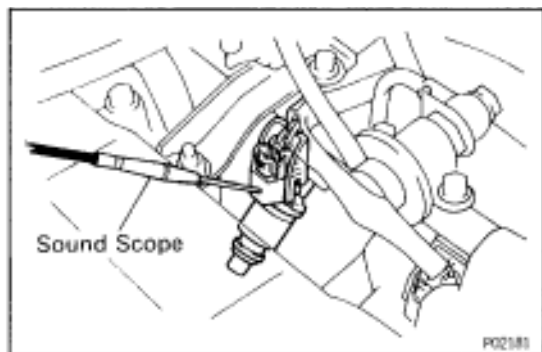

SERVICE SPECIFICATIONS

SERVICE DATA

Fuel pressure regulator	Fuel pressure at no vacuum	265–304 kPa (2.7–3.1 kgf/cm ² , 38–44 psi)
Fuel pump	Resistance at 20°C (68°F)	0.2–3.0 Ω
Injector	Resistance Injection volume Difference between each cylinder Fuel leakage	13.4–14.2 Ω 70–88 cm ³ (4.3–5.4 cu in.) per 15 sec. 9 cm ³ (0.5 cu in.) or less One drop or less per minute
VAF meter	Resistance (THA-E2) at –20°C (–4°F) at 0°C (32°F) at 20°C (68°F) at 40°C (104°F) at 60°C (140°F)	10–20 kΩ 4–7 kΩ 2–3 kΩ 0.9–1.3 kΩ 0.4–0.7 kΩ
Throttle body	Throttle body fully closed angle Dashpot setting speed M/T A/T Throttle opener setting speed	6° 2,600 ± 400 rpm 1,800 ± 400 rpm 1,500 ± 400 rpm
Throttle position sensor	Clearance between stop screw and lever 0 mm (0 in.) VTA-E2 0.40 mm (0.016 in.) IDL-E2 0.60 mm (0.024 in.) IDL-E2 Throttle valve fully open VTA-E2 – VC-E2	0.34–6.3 kΩ 0.5 kΩ or less Infinity 2.4–11.2 kΩ 3.1–7.2 kΩ
IAC valve	Resistance B1 (or B2)–Others	18–22 Ω
VSV for ACIS	Resistance at 20°C (68°F)	38.5–44.5 Ω
VSV for Fuel pressure control (California only)	Resistance at 20°C (68°F)	33–39 Ω
VSV for EVAP	Resistance at 20°C (68°F)	27–33 Ω
VSV for EGR	Resistance at 20°C (68°F)	38.5–44.5 Ω
ECT sensor	Resistance at –20°C (–4°F) at 0°C (32°F) at 20°C (68°F) at 40°C (104°F) at 60°C (140°F) at 80°C (176°F)	10–20 kΩ 4–7 kΩ 2–3 kΩ 0.9–1.3 kΩ 0.4–0.7 kΩ 0.2–0.4 kΩ
EGR gas temperature sensor	Resistance at 50°C (122°F) at 100°C (212°F) at 150°C (302°F)	64–97 kΩ 11–16 kΩ 2–4 kΩ
Main heated oxygen sensor (California)	Heater coil resistance at 20°C (68°F)	11–16 Ω

Sub heated oxygen sensor (California only)	Heater coil resistance at 20°C (68°F)	11-16 Ω
Fuel cut rpm	Fuel return rpm	1,400 rpm

TORQUE SPECIFICATIONS

Part tightened	N·m	kgf·cm	ft·lbf	
Fuel line	for union bolt	29	300	22
	for flare nut	30	310	22
Fuel pressure regulator x Delivery pipe	8.8	90	78 in.·lbf	
Delivery pipe x Intake manifold	21	210	15	
Actuator for ACIS x Air intake chamber	6.8	70	61 in.·lbf	
Fuel inlet pipe x Delivery pipe	41	420	30	
Fuel return pipe x Fuel pressure regulator	27	280	20	
Air intake chamber stay x Cylinder head	18	185	13	
Air intake chamber stay x Air intake chamber	18	185	13	
Intake air connector x Air intake chamber	27	270	20	
Throttle body bracket x Throttle body	21	210	15	
Throttle body bracket x Cylinder head	21	210	15	
No.2 vacuum pipe x Intake manifold	27	270	20	
EGR pipe x Cylinder head	27	270	20	
EGR pipe x EGR valve	64	650	47	
Fuel pressure pulsation damper x Fuel pipe support		41	420	30
	for SST	35	350	25
Starter x Transmission	39	400	29	
Fuel tank band x Body	39	400	29	
VAF meter x Air cleaner case	10	100	7	
Throttle body x Intake air connector	21	210	15	
Vacuum tank x Intake manifold	21	210	15	
Brake booster union x Air intake chamber	29	300	22	
Air intake chamber x Intake manifold	27	270	20	
EGR gas temperature sensor x EGR valve	20	200	14	
Knock sensor x Cylinder block	44	450	33	
Oxygen sensor (Except California) x Exhaust manifold	20	200	14	
Main heated oxygen sensor (California) x Exhaust manifold	44	450	33	
Sub heated oxygen sensor (California only) x Center exhaust pipe	20	200	14	