

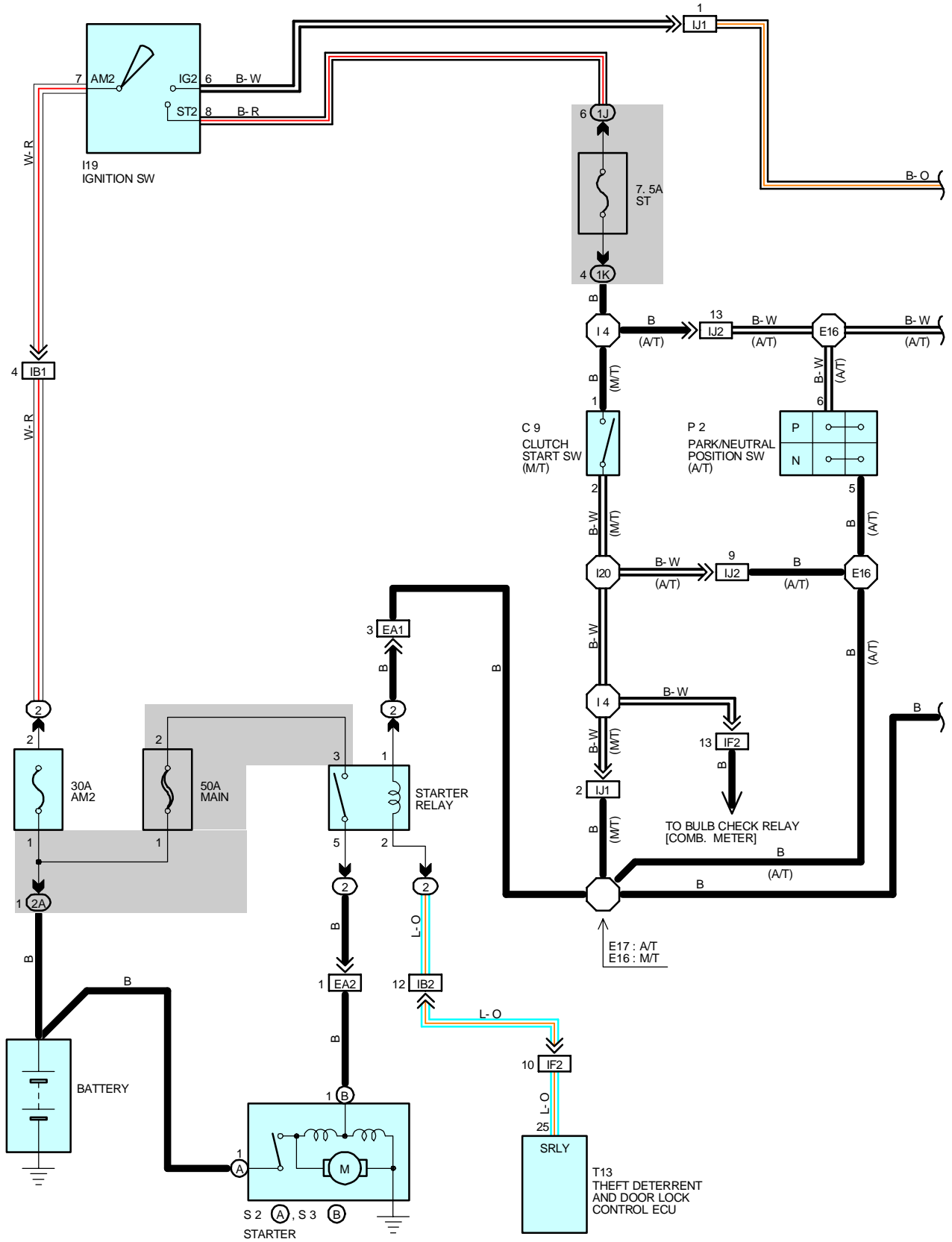

STARTING AND IGNITION (2JZ-GTE)

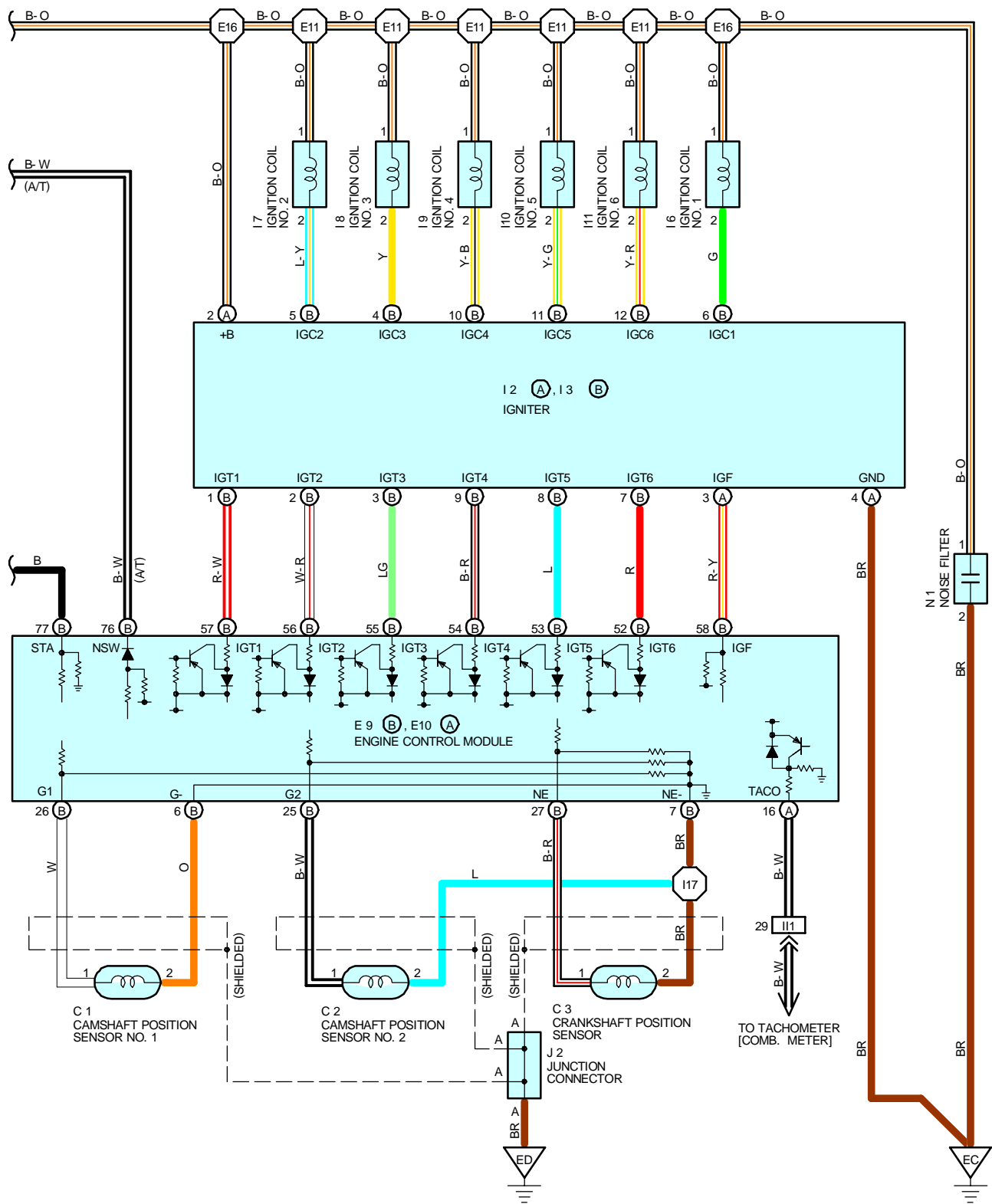





STARTING AND IGNITION (2JZ-GTE)

SERVICE HINTS

I19 IGNITION SW

- 7-8 : CLOSED WITH THE IGNITION SW AT **ST** POSITION
- 7-6 : CLOSED WITH THE IGNITION SW AT **ON** OR **ST** POSITION

P2 PARK/NEUTRAL POSITION SW (A/T)

- 6-5 : CLOSED WITH THE A/T SHIFT LEVER IN **P** OR **N** POSITION

C9 CLUTCH START SW (M/T)

- 1-2 : CLOSED WITH THE CLUTCH PEDAL FULLY DEPRESSED

S2 (A), S3 (B) STARTER

- POINTS CLOSED WITH THE PARK/NEUTRAL POSITION SW ON AND THE IGNITION SW AT **ST** POSITION (A/T)
- POINTS CLOSED WITH THE CLUTCH START SW ON AND THE IGNITION SW AT **ST** POSITION (M/T)

○ : PARTS LOCATION

CODE	SEE PAGE	CODE	SEE PAGE	CODE	SEE PAGE
C1	24	I3	B 25	J2	29
C2	24	I6	25	N1	25 (2JZ-GTE)
C3	24 (2JZ-GTE)	I7	25	P2	25 (2JZ-GTE)
C9	28	I8	25	S2	A 25 (2JZ-GTE)
D1	24 (2JZ-GTE)	I9	25	S3	B 25 (2JZ-GTE)
E9	B 29	I10	25	T13	29
E10	A 29	I11	25		
I2	A 25	I19	29		

○ : RELAY BLOCKS

CODE	SEE PAGE	RELAY BLOCKS (RELAY BLOCK LOCATION)
2	22	R/B NO. 2 (ENGINE COMPARTMENT LEFT)

○ : JUNCTION BLOCK AND WIRE HARNESS CONNECTOR

CODE	SEE PAGE	JUNCTION BLOCK AND WIRE HARNESS (CONNECTOR LOCATION)
1J	20	COWL WIRE AND J/B NO. 1 (LEFT KICK PANEL)
IK		
2A	22	BATTERY AND J/B NO. 2 (ENGINE COMPARTMENT LEFT)

□ : CONNECTOR JOINING WIRE HARNESS AND WIRE HARNESS

CODE	SEE PAGE	JOINING WIRE HARNESS AND WIRE HARNESS (CONNECTOR LOCATION)
EA1	32(2JZ-GTE)	ENGINE WIRE AND ENGINE ROOM MAIN WIRE (NEAR THE R/B NO. 2)
EA2	32	
IB1	36	ENGINE ROOM MAIN WIRE AND COWL WIRE (LEFT KICK PANEL)
IB2		
IF2	36	INSTRUMENT PANEL WIRE AND COWL WIRE (INSTRUMENT PANEL REINFORCEMENT LH)
II1	38	ENGINE WIRE AND INSTRUMENT PANEL WIRE (RIGHT KICK PANEL)
IJ1	38	ENGINE WIRE AND COWL WIRE (RIGHT KICK PANEL)
IJ2		

▽ : GROUND POINTS

CODE	SEE PAGE	GROUND POINTS LOCATION
EC	32 (2JZ-GTE)	FRONT SIDE OF INTAKE MANIFOLD
ED	32 (2JZ-GTE)	REAR SIDE OF INTAKE MANIFOLD

○ : SPLICE POINTS

CODE	SEE PAGE	WIRE HARNESS WITH SPLICE POINTS	CODE	SEE PAGE	WIRE HARNESS WITH SPLICE POINTS
E11	32	ENGINE WIRE	I4	38	COWL WIRE
E16			I17		
E17			I20		

C 1 BLACK



C 2 BLACK



C 3 DARK GRAY



C 9

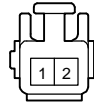

E 9 (B) DARK GRAY

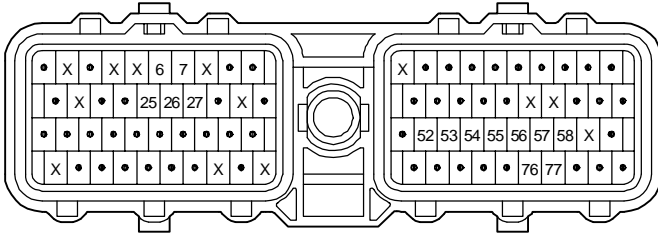

E10 (A) DARK GRAY

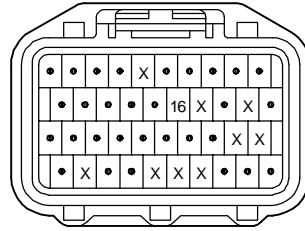

I 2 (A) BLACK



I 3 (B) BLACK

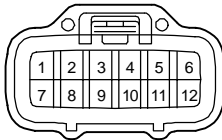

I 6, I 7, I 8, I 9, I 10, I 11 BLACK

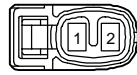

I19

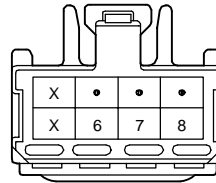

J 2

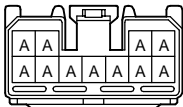

(HINT : SEE PAGE 7)

N 1 GRAY



P 2 GRAY

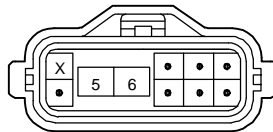

S 2 (A)

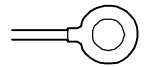

S 3 (B) BLACK



T13 ORANGE

