

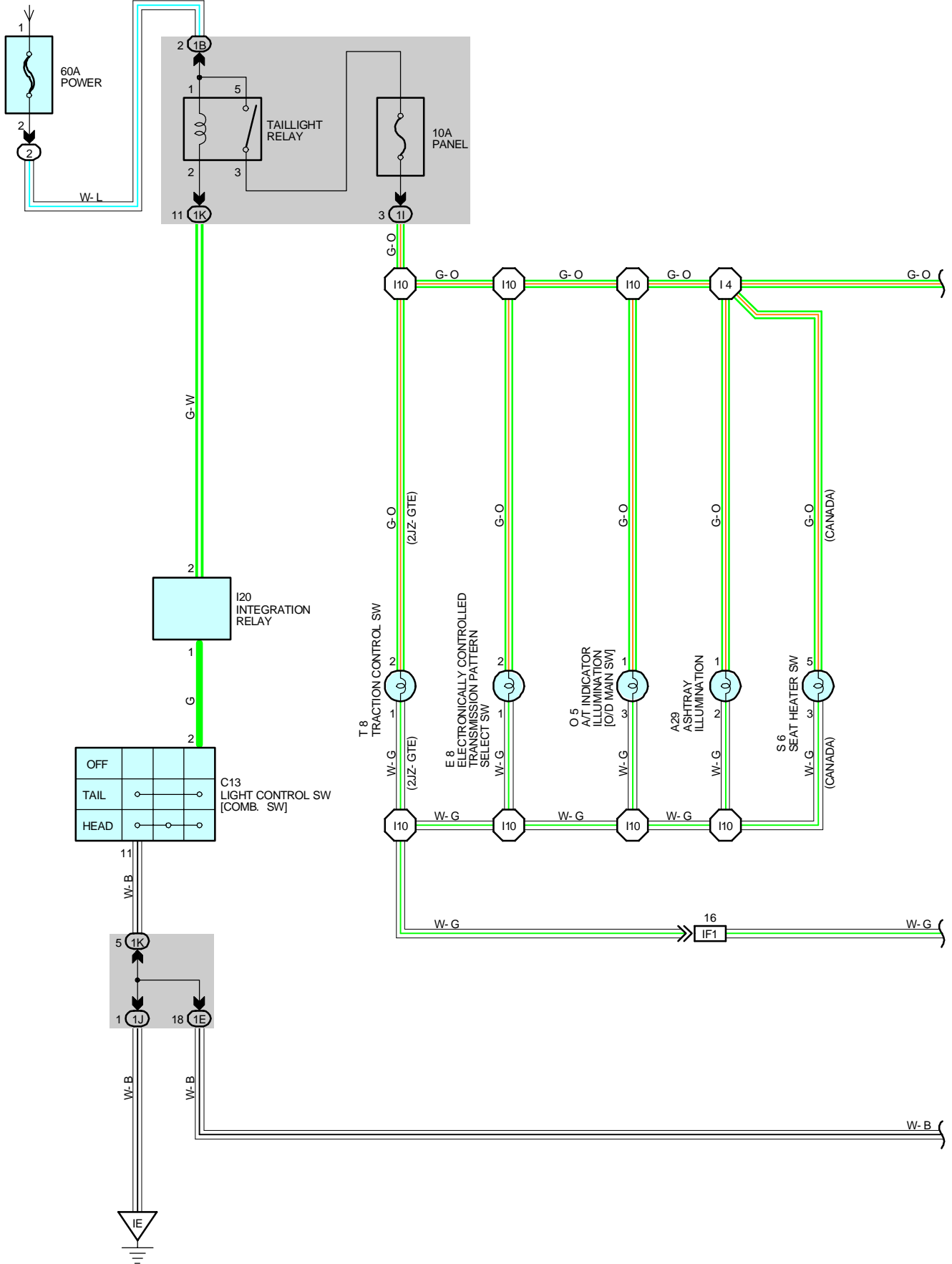

# ILLUMINATION

FROM POWER SOURCE SYSTEM (SEE PAGE 56)

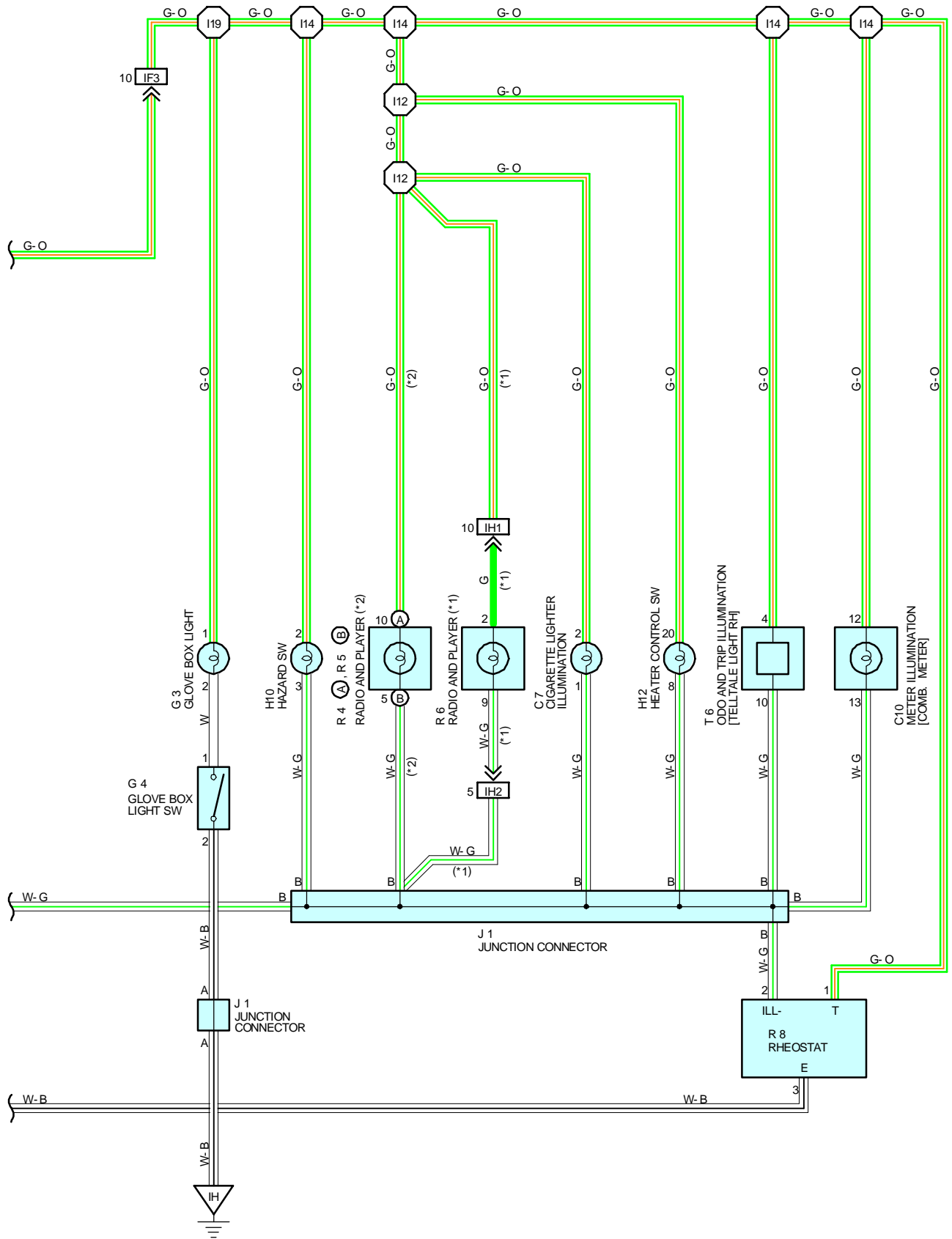





# ILLUMINATION

## SERVICE HINTS

### TAILLIGHT RELAY

5-3 : CLOSED WITH THE LIGHT CONTROL SW AT **TAIL** OR **HEAD** POSITION

### C13 LIGHT CONTROL SW [COMB. SW]

2-1 1 : CLOSED WITH THE LIGHT CONTROL SW AT **TAIL** OR **HEAD** POSITION

## ○ : PARTS LOCATION

CODE	SEE PAGE	CODE	SEE PAGE	CODE	SEE PAGE
A29	28	H10	29	R 6	29
C 7	28	H12	29	R 8	29
C10	28	I20	29	S 6	29
C13	28	J 1	29	T 6	29
E 8	29	O 5	29	T 8	29
G 3	29	R 4	A	29	
G 4	29	R 5	B	29	

## ○ : RELAY BLOCKS

CODE	SEE PAGE	RELAY BLOCKS (RELAY BLOCK LOCATION)
2	22	R/B NO. 2 (ENGINE COMPARTMENT LEFT)

## ○ : JUNCTION BLOCK AND WIRE HARNESS CONNECTOR

CODE	SEE PAGE	JUNCTION BLOCK AND WIRE HARNESS (CONNECTOR LOCATION)
1B	20	ENGINE ROOM MAIN WIRE AND J/B NO. 1 (LEFT KICK PANEL)
1E	20	INSTRUMENT PANEL WIRE AND J/B NO. 1 (LEFT KICK PANEL)
1I	20	COWL WIRE AND J/B NO. 1 (LEFT KICK PANEL)
1J		
1K		

## □ : CONNECTOR JOINING WIRE HARNESS AND WIRE HARNESS

CODE	SEE PAGE	JOINING WIRE HARNESS AND WIRE HARNESS (CONNECTOR LOCATION)
IF1	36	INSTRUMENT PANEL WIRE AND COWL WIRE (INSTRUMENT PANEL REINFORCEMENT LH)
IF3	36	INSTRUMENT PANEL WIRE AND COWL WIRE (RIGHT KICK PANEL)
IH1	38	INSTRUMENT PANEL AND CONSOLE BOX WIRE (UNDER THE INSTRUMENT PANEL BRACE RH)
IH2		

## ▽ : GROUND POINTS

CODE	SEE PAGE	GROUND POINTS LOCATION
IE	36	LEFT KICK PANEL
IH	36	RIGHT KICK PANEL

## ○ : SPLICE POINTS

CODE	SEE PAGE	WIRE HARNESS WITH SPLICE POINTS	CODE	SEE PAGE	WIRE HARNESS WITH SPLICE POINTS
I 4	38	COWL WIRE	I14	38	INSTRUMENT PANEL WIRE
I10	38	COWL WIRE	I19		
I12	38	INSTRUMENT PANEL WIRE			

A29

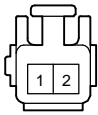

C 7 BLACK

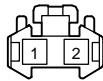

C10 BLUE

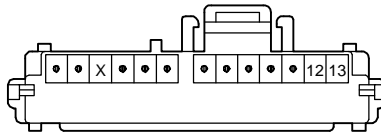

C13 BLACK

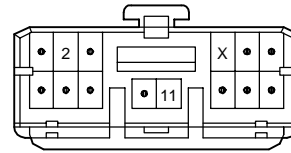

E 8

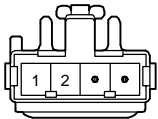

G 3 BLACK

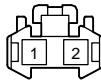

G 4 BLACK

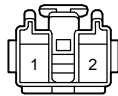

H10

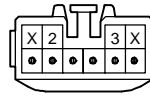

H12 ORANGE

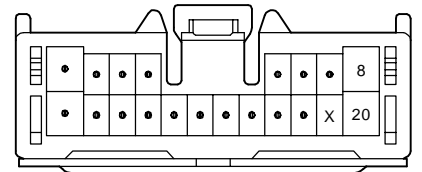

I20

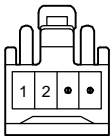

J 1

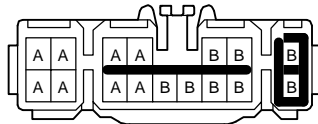

(HINT : SEE PAGE 7)

O 5 BLUE

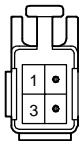

R 4 (A)

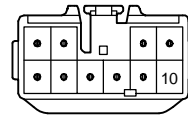

R 5 (B)

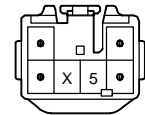

R 6

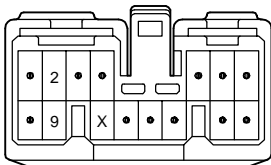

R 8

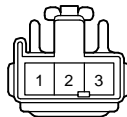

S 6 BLACK

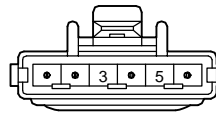

T 6

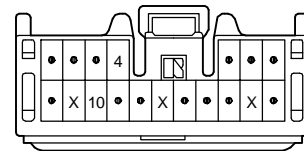

T 8 BLACK

